

## 10A 700V N-channel Enhancement Mode Power MOSFET

### 1 Description

These N-channel enhanced vdmofets, is obtained by the self-aligned planar technology which reduce the conduction loss, improve switching performance and enhance the avalanche energy. Which accords with the RoHS standard. TO-220F provides insulation voltage rated at 2000V RMS from all three terminals to external heatsink. TO-220F series comply with UL standards (File ref:E252906).

### 2 Features

- Fast switching
- ESD improved capability
- Low on resistance( $R_{dson} \leq 1.1\Omega$ )
- Low gate charge(Typ: 34nC)
- Low reverse transfer capacitances(Typ: 6.2pF)
- 100% single pulse avalanche energy test
- 100%  $\Delta V_{DS}$  test

### 3 Applications

- Used in various power switching circuit for system miniaturization and higher efficiency.
- Power switch circuit of electron ballast and adaptor.

### 4 Electrical Characteristics

#### 4.1 Absolute Maximum Ratings (Tc=25°C, unless otherwise noted)

PARAMETER	SYMBOL	VALUE	UNIT
Drian-Source Voltage	$V_{DS}$	700	V
Gate-Source Voltage	$V_{GS}$	$\pm 30$	V
Drain Current(continuous) <sup>(Note 3)</sup>	$I_D$	10	A
Drain Current(continuous)(T=100°C) <sup>(Note 3)</sup>	$I_D$	6.3	A
Drain Current(Pulsed)	$I_{DM}$	40	A
Single Pulse Avalanche Energy <sup>(Note 4)</sup>	$E_{AS}$	500	mJ
Derating Factor above	$P_D$	0.32	W
Power Dissipation		40	W
Operating Junction Temperature Range	$T_j$	-55~150	°C
Storage Temperature Range	$T_{stg}$	-55~150	°C
High Temperature(tin solder)	$T_L$	300	°C

#### 4.2 Thermal Characteristics

PARAMETER	SYMBOL	VALUE	UNIT
Thermal Resistance, Junction to Case-sink	$R_{thJC}$	3.15	°C/W
Thermal Resistance, Junction to Ambient	$R_{thJA}$	62.5	°C/W

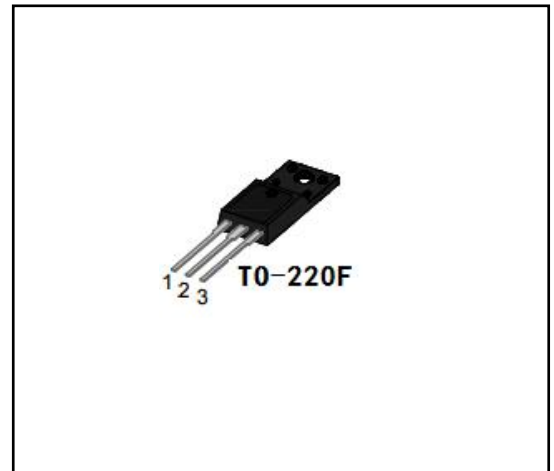
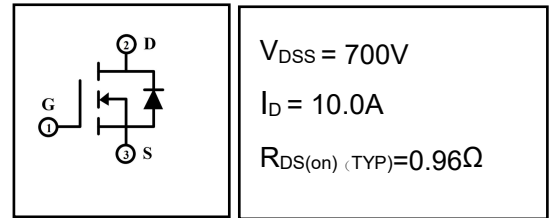

**4.3 Electrical Characteristics** (Tc=25°C, unless otherwise noted)

PARAMETER	SYMBOL	Test Condition	VALUE			UNIT
			MIN	TYP	MAX	
<b>Off Characteristics</b>						
Drain-source Breakdown Voltage	BV <sub>DSS</sub>	I <sub>D</sub> =250μA, V <sub>GS</sub> =0V	700	--	--	V
Zero Gate Voltage Drain Current	I <sub>DSS</sub>	V <sub>DS</sub> =700V, V <sub>GS</sub> =0V, T <sub>C</sub> =25°C	--	--	1	μA
		V <sub>DS</sub> =560V, V <sub>GS</sub> =0V, T <sub>C</sub> =125°C	--	--	100	μA
Gate-to-Body Leakage Current	I <sub>GSS</sub>	V <sub>GS</sub> =±30V, V <sub>DS</sub> =0V	--	--	±100	nA
<b>On Characteristics</b> (Note 3)						
Gate threshold voltage	V <sub>GS(th)</sub>	V <sub>DS</sub> =V <sub>GS</sub> , I <sub>D</sub> =250μA	2.0	--	4.0	V
Drain-source on Resistance	R <sub>DS(on)</sub>	V <sub>GS</sub> =10V, I <sub>D</sub> =5.0A	--	0.96	1.1	Ω
<b>Dynamic Characteristics</b>						
Input Capacitance	C <sub>iss</sub>	V <sub>GS</sub> =0V, V <sub>DS</sub> =25V, f=1.0MHz	--	1563	--	pF
Output Capacitance	C <sub>oss</sub>		--	120	--	
Reverse Transfer Capacitance	C <sub>rss</sub>		--	6.2	--	
Turn-on Delay Time	T <sub>d(on)</sub>	I <sub>D</sub> =10A, V <sub>DD</sub> =350V, V <sub>GS</sub> =10V, R <sub>G</sub> =10Ω	--	25.6	--	ns
Turn-on Rise Time	t <sub>r</sub>		--	24.8	--	
Turn-off Delay Time	T <sub>d(off)</sub>		--	48.2	--	
Turn-off Fall	t <sub>f</sub>		--	30.4	--	
Total Gate Charge	Q <sub>g</sub>	I <sub>D</sub> =10A, V <sub>DD</sub> =560V, V <sub>GS</sub> =10V	--	34	--	nc
Gate-to-Source Charge	Q <sub>gs</sub>		--	7.2	--	
Gate-to-Drain("Miller")C harge	Q <sub>gd</sub>		--	15.2	--	
<b>Drain-Source Diode Characteristics</b>						
Diode Forward Voltage (Note 3)	V <sub>FSD</sub>	V <sub>GS</sub> =0V, I <sub>S</sub> =10A	--	--	1.5	V
Continuous Source Current (BodyDiode) (Note 3)	I <sub>S</sub>		--	--	10	A
Reverse Recovery Time	t <sub>rr</sub>	T <sub>J</sub> =25°C, I <sub>F</sub> =10A, dI <sub>F</sub> /dt=100A/μS, V <sub>GS</sub> =0V	--	510	--	ns
Reverse Recovery Charge	Q <sub>rr</sub>		--	3920	--	nc

Notes:

- 1: Repetitive rating, pulse width limited by maximum junction temperature.
- 2: Surface mounted on FR4 Board, t≤10sec.
- 3: Pulse width ≤ 300μs, duty cycle ≤ 2%.
- 4: L=10mH, I<sub>D</sub>=10A, V<sub>DD</sub>=50V, Start T<sub>J</sub>=25°C.

**5 Typical Test Circuit and Waveform**

<p style="text-align: center;">Gate Charge Test Circuit</p>	<p style="text-align: center;">Gate Charge Waveforms</p>
<p style="text-align: center;">Resistive Switching Test Circuit</p>	<p style="text-align: center;">Resistive Switching Waveforms</p>
<p style="text-align: center;">Diode Reverse Recovery Test Circuit</p>	<p style="text-align: center;">Diode Reverse Recovery Waveform</p> $E_{AS} = \frac{I_{AS}^2 L}{2}$
<p style="text-align: center;">Unclamped Inductive Switching Test Circuit</p>	<p style="text-align: center;">Unclamped Inductive Switching Waveform</p>

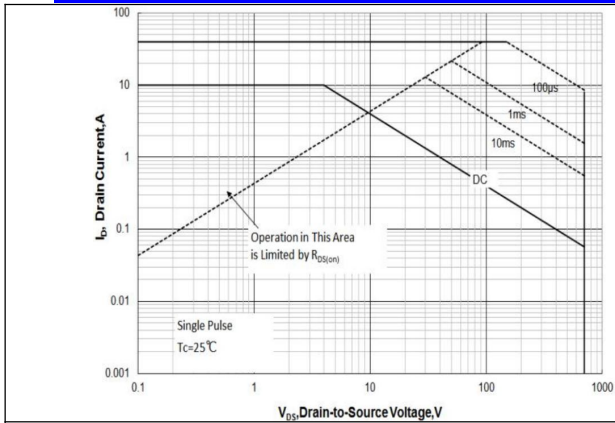

Maximum Forward Bias Safe Operating Area

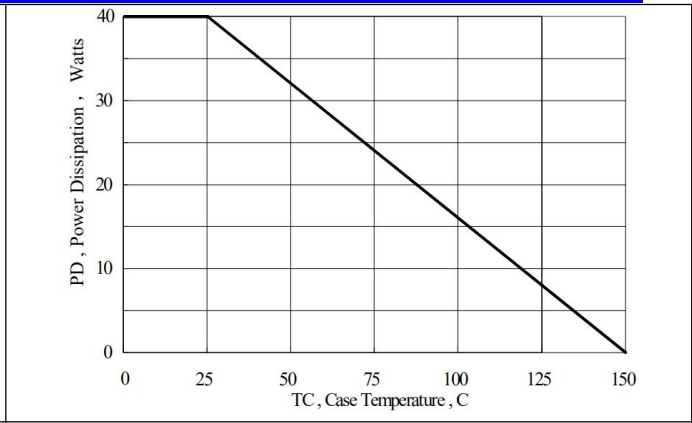

Maximum Power Dissipation vs Case Temperature

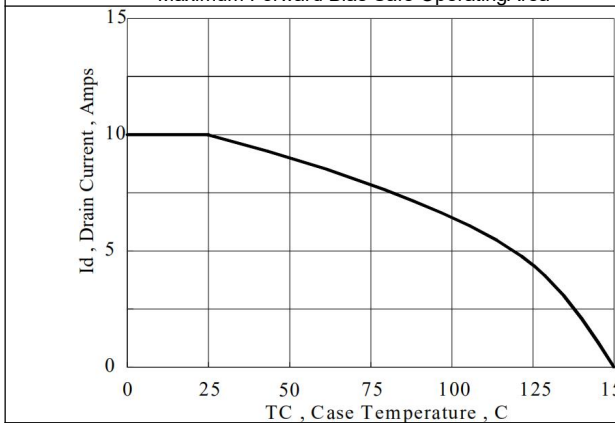

Maximum Continuous Drain Current vs Case Temperature

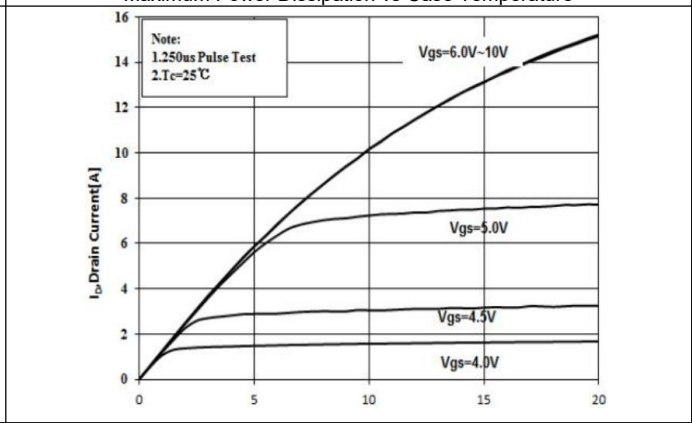

Typical Output Characteristics

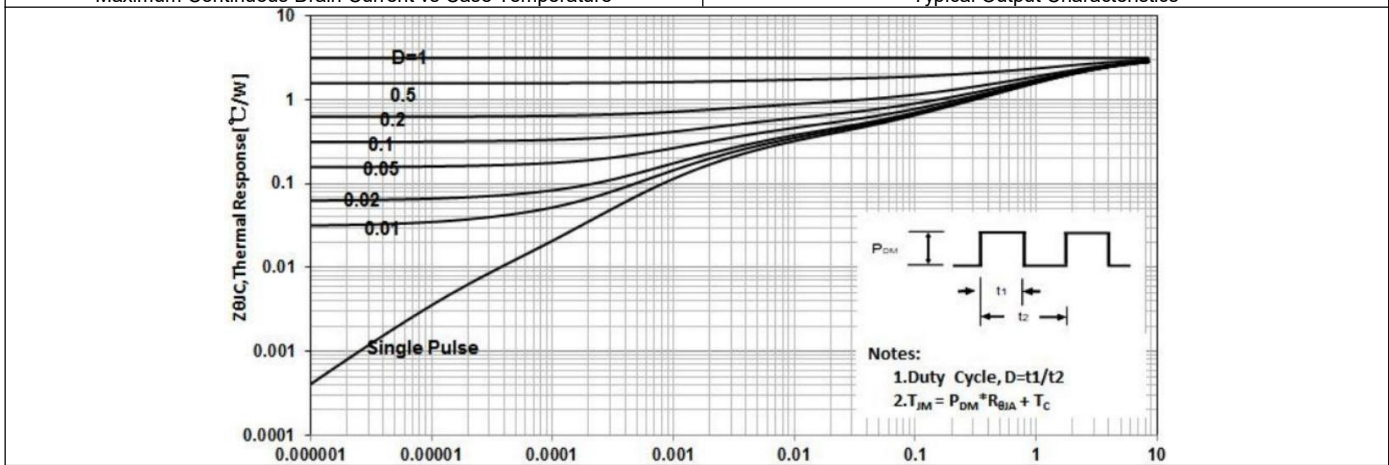

Maximum Effective Thermal Impedance, Junction to Case

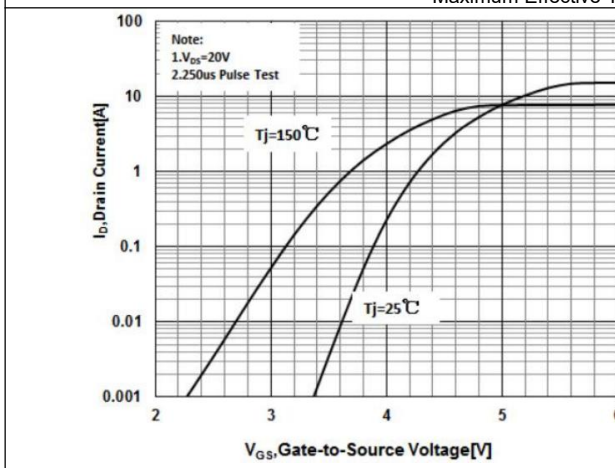

Typical Transfer Characteristics

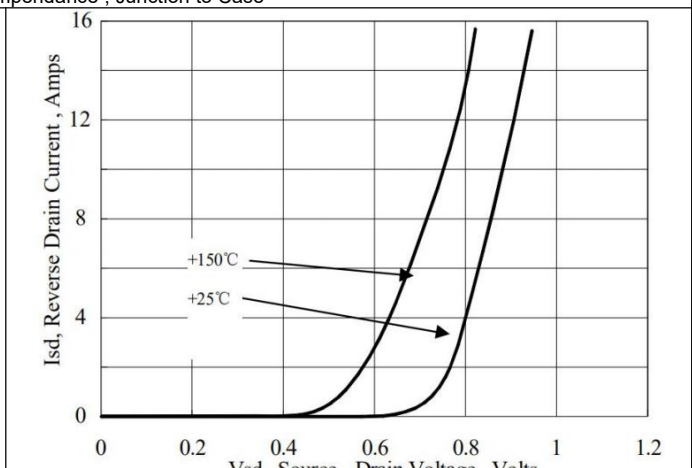

Typical Body Diode Transfer Characteristics

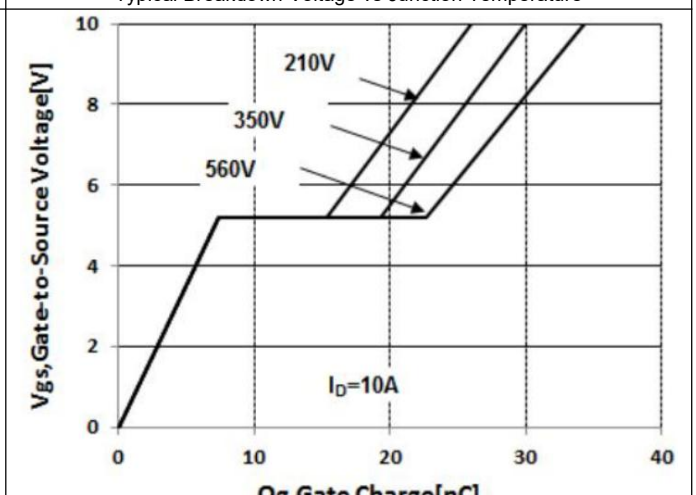
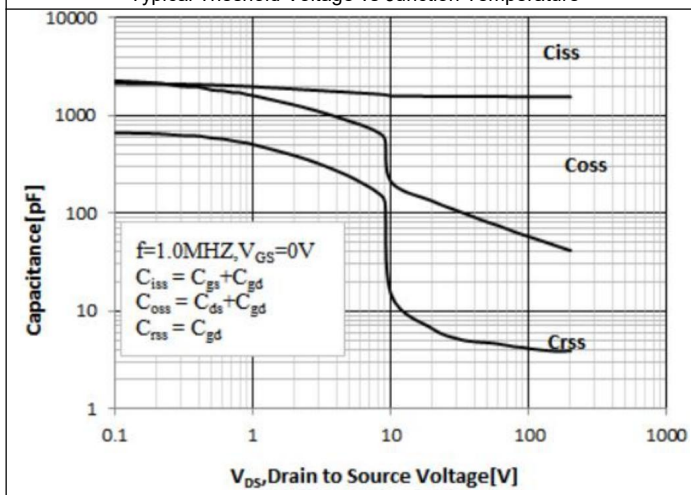
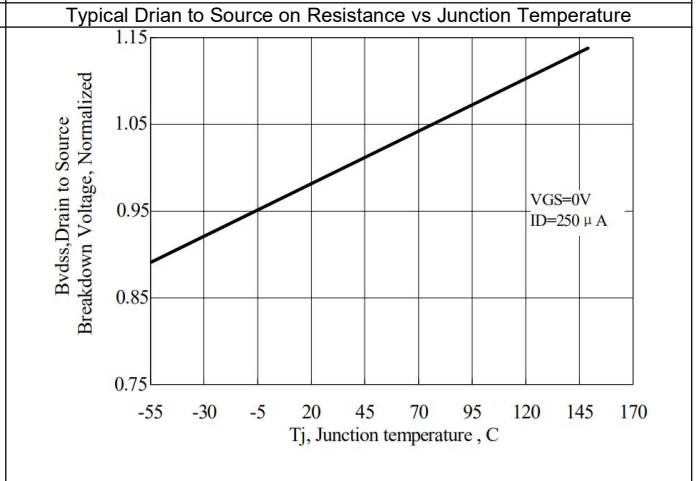
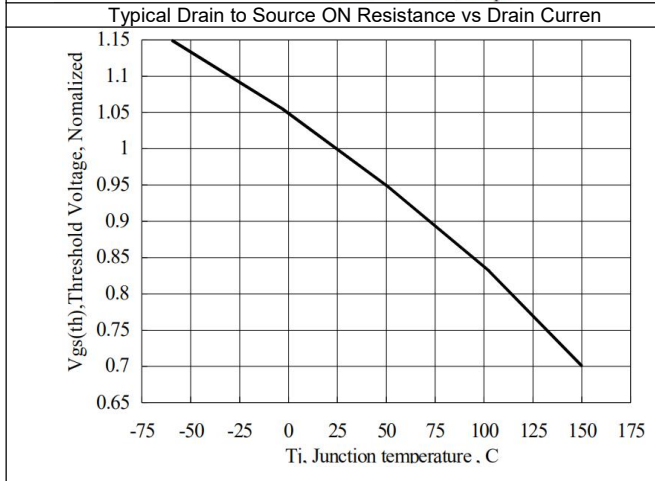
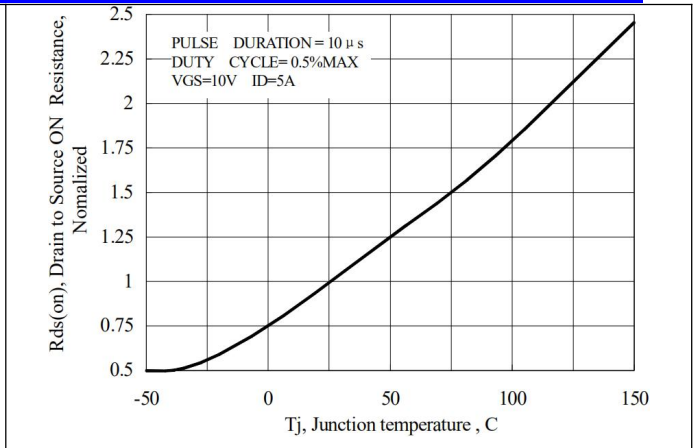
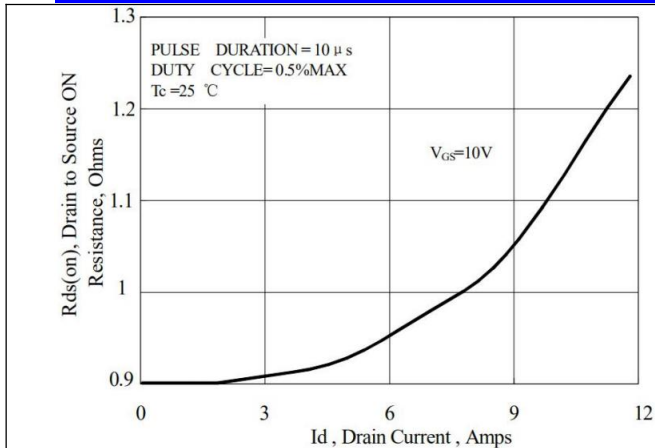

## 7 Product Specifications and Packaging Models

Product Model	Package Type	Mark Name	RoHS	Package	Quantity
F10N70	TO-220F	F10N70	Pb-free	Tube	1000/box

## 8 Dimensions

TO-220F PACKAGE OUTLINE DIMENSIONS

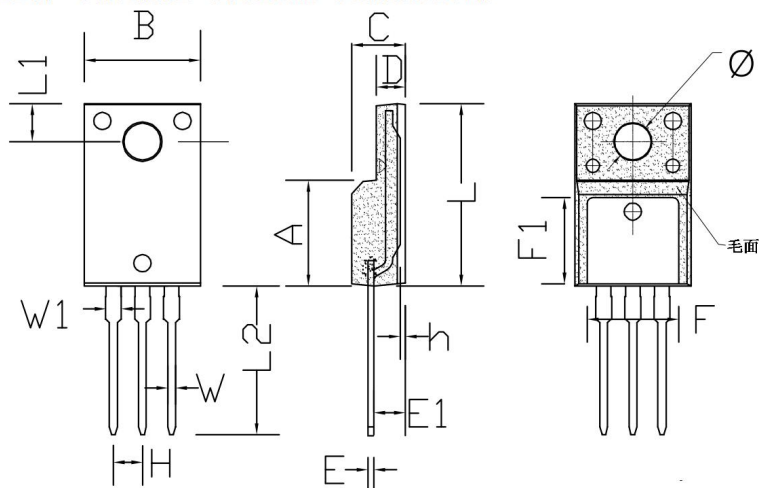

Symbol	Dimensions In Millimeters		Dimensions In Inches	
	min.	max.	min.	max.
A	8.80	9.30	0.346	0.366
B	10.00	10.50	0.394	0.413
C	4.30	4.90	0.169	0.193
D	2.30	2.70	0.091	0.106
L	15.55	16.15	0.612	0.636
h	0.40	0.60	0.016	0.024
L1	3.15	3.55	0.124	0.140
L2	12.65	13.35	0.498	0.526
W	0.70	0.90	0.028	0.035
W1	1.15	1.55	0.045	0.061
H	2.54 TYP		0.100 TYP	
E	0.48	0.53	0.019	0.021
φ	2.90	3.40	0.114	0.134
E1	2.40	2.90	0.094	0.114
F	7.75	8.25	0.305	0.325
F1	7.35	7.85	0.289	0.309

## 9 Attentions

- Jiangsu Donghai Semiconductor Co.,Ltd. reserves the right to change the specification without prior notice! The customer should obtain the latest version of the information before making the order and verify that the information is complete and up to date.
- It is the responsibility of the purchaser for any failure or failure of any semiconductor product under certain conditions. It is the responsibility of the purchaser to comply with safety standards and to take safety measures in the system design and machine manufacturing of Jiangsu Donghai Semiconductor Co.,Ltd. products in order to avoid potential risk of failure. Injury or property damage.
- Product promotion is endless, our company will be dedicated to provide customers with better products.

## 10 Appendix

Revision history:

Date	REV.	Description	Page
2022.03.09	1.0	Original	