

## 16A 200V Fast recovery diode

### 1 Description

16A, 200V Ultrafast Diodes They have a low forward voltage drop and are of planar, silicon nitride passivated, ion-implanted, epitaxial construction. These devices are intended for use as energy steering/clamping diodes and rectifiers in a variety of switching power supplies and other power switching applications. Their low stored charge and ultrafast recovery with soft recovery characteristics minimizes ringing and electrical noise in many power switching circuits, thus reducing power loss in the switching transistor

TO-220F provides insulation voltage rated at 2000V RMS from all three terminals to external heatsink.

### 2 Features

- Low power loss,
- high efficiency Low forward voltage,
- high current capability High surge capacity
- Super fast recovery times
- high voltage

### 3 Applications

- Switching Power Supply
- Power Switching Circuits
- General Purpose

1. Anode 2. Cathode 3. Anode

$V_{BR} = 200V$

$V_{F(Max)(single)} = 0.98V$

$I_{F(AV)(single)} = 8A$

### 4 Electrical Characteristics

#### 4.1 Absolute Maximum Ratings (Tc=25°C, unless otherwise noted)

PARAMETER		SYMBOL	VALUE	UNIT
Peak Repetitive Reverse Voltage		$V_{RRM}$	200	V
Working Peak Reverse Voltage		$V_{RWM}$	200	V
DC Blocking Voltage		$V_R$	200	V
Average Rectified Forward Current(single)	TO-220/252/251/263, TC=135°C TO-220F, TC=100°C	$I_{F(AV)}$	8	A
Average Rectified Forward Current(double)			16	A
Repetitive Peak Surge Current(single)		$I_{FRM}$	12	A
Nonrepetitive Peak Surge Current(single)	tp=8.3ms	$I_{FSM}$	80	A
Avalanche Energy(single)	L=1mH	$E_{AS}$	10	mJ
Operating Junction Temperature Range		$T_j$	-55~150	°C
Storage Temperature Range		$T_{stg}$	-55~150	°C

#### 4.2 Thermal Characteristics

PARAMETER	SYMBOL	VALUE				UNIT
		TO-220	TO-220F	TO-252/251	TO-263	
Thermal Resistance, Junction to Case-sink	$R_{thJC}$	1.6	2.5	2.5	1.3	°C/W

## 4.3 Electrical Characteristics (Tc=25°C, unless otherwise noted)

PARAMETER	SYMBOL	TEST CONDITION	MIN	TYP	MAX	UNIT
Maximum Instantaneous Forward Voltage	V <sub>F</sub>	I <sub>F</sub> = 6A	-	0.90	-	V
		I <sub>F</sub> = 8A	-	0.94	0.98	V
		I <sub>F</sub> = 8A, T <sub>C</sub> = 150°C	-	-	0.88	V
		I <sub>F</sub> = 12A	-	1.05	1.30	V
Maximum Instantaneous Reverse	I <sub>R</sub>	V <sub>R</sub> = 200V	-	-	5	μA
		V <sub>R</sub> = 200V, T <sub>C</sub> = 150°C	-	-	1	mA
Maximum Reverse Recovery Time	t <sub>rr</sub>	V <sub>R</sub> =30V I <sub>F</sub> =1A -di/dt=50A/us	-	22	35	ns
Total capacitance	C <sub>tot</sub>	V <sub>R</sub> =0V f=1MHz	-	135	-	pF
DC Blocking Voltage	V <sub>BR</sub>	I <sub>R</sub> =100μA	210	240	-	V

### DEFINITIONS

V<sub>F</sub> = Instantaneous forward voltage (pw = 300μs, D = 2%).

I<sub>R</sub> = Instantaneous reverse current.

RθJC = Thermal resistance junction to case.

pw = pulse width.

D = duty cycle.

## 5 Typical characteristics diagrams

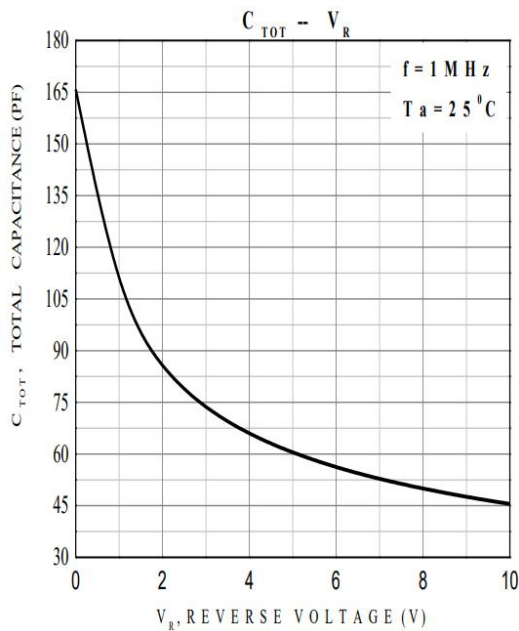

FIGURE 1. Total capacitance vs Voltage

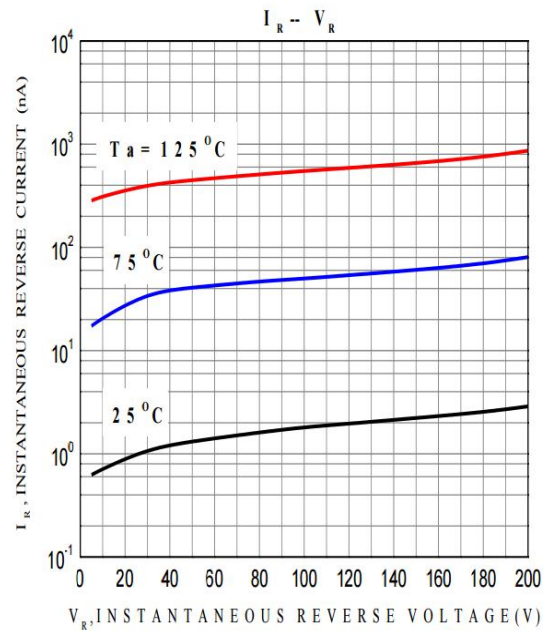

FIGURE 2. REVERSE CURRENT vs REVERSE VOLTAGE

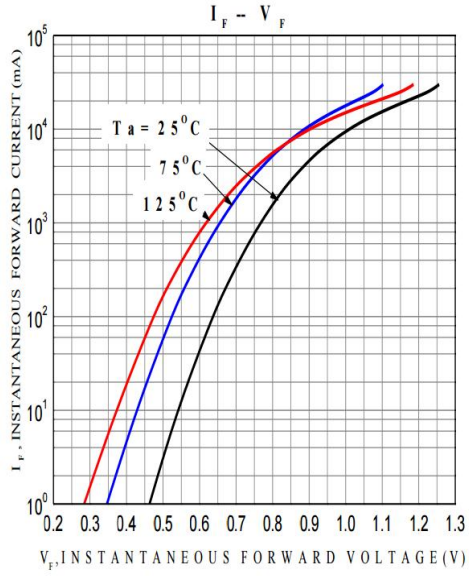

FIGURE 3. FORWARD CURRENT vs FORWARD VOLTAGE

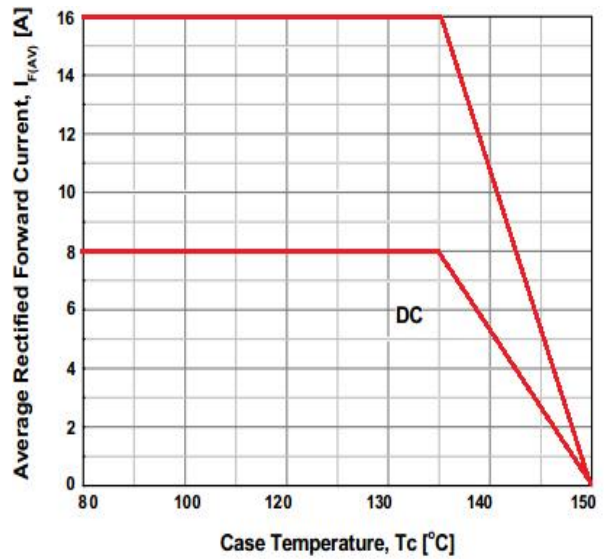

FIGURE 4. CURRENT DERATING CURVE

## 6 Typical Test Circuit and Waveform

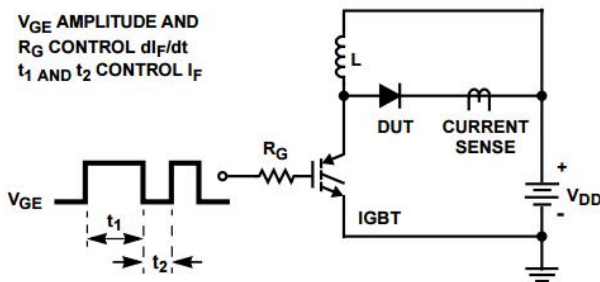

FIGURE 5. trr TEST CIRCUIT

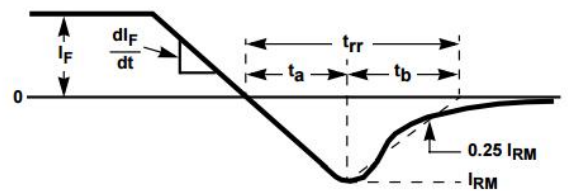

FIGURE 6. trr WAVEFORMS AND DEFINITIONS

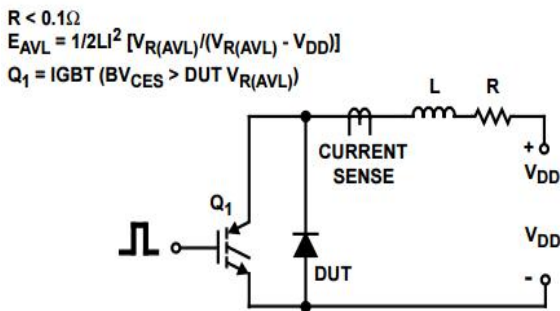

FIGURE 7. AVALANCHE ENERGY TEST CIRCUIT FIGURE

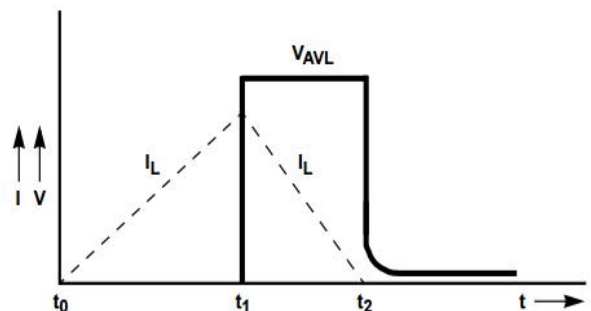

FIGURE 8. AVALANCHE CURRENT AND VOLTAGE WAVEFORMS

## 7 Product Specifications and Packaging Models

Product Model	Package Type	Mark Name	RoHS	Package	Quantity
MUR1620CT	TO-220	MUR1620CT	Pb-free	Tube	1000/box
MURD1620CT	TO-252	MURD1620CT	Pb-free	Braid	3000/disc
MURF1620CT	TO-220F	MURF1620CT	Pb-free	Tube	1000/box
MUR1620CT	TO-263	MUR1620CT	Pb-free	Tube	1000/box

## 8 Dimensions

TO-220F PACKAGE OUTLINE DIMENSIONS

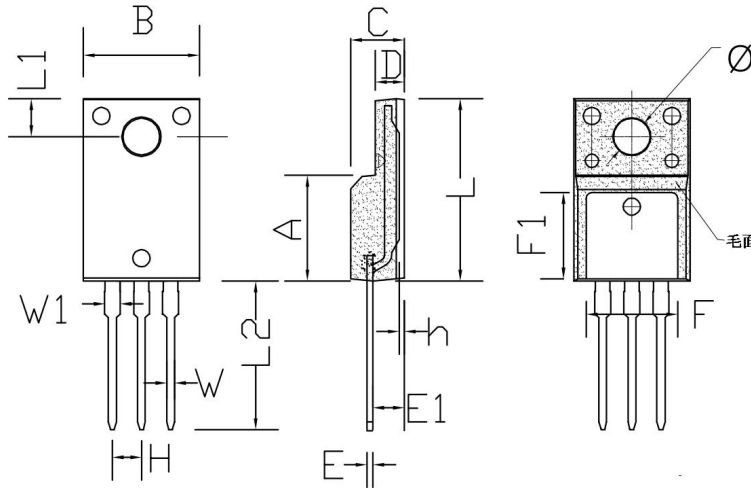

Symbol	Dimensions In Millimeters		Dimensions In Inches	
	min.	max.	min.	max.
A	8.80	9.30	0.346	0.366
B	10.00	10.50	0.394	0.413
C	4.30	4.90	0.169	0.193
D	2.30	2.70	0.091	0.106
L	15.55	16.15	0.612	0.636
h	0.40	0.60	0.016	0.024
L1	3.15	3.55	0.124	0.140
L2	12.65	13.35	0.498	0.526
W	0.70	0.90	0.028	0.035
W1	1.15	1.55	0.045	0.061
H	2.54 TYP		0.100 TYP	
E	0.48	0.53	0.019	0.021
φ	2.90	3.40	0.114	0.134
E1	2.40	2.90	0.094	0.114
F	7.75	8.25	0.305	0.325
F1	7.35	7.85	0.289	0.309

TO-220C PACKAGE OUTLINE DIMENSIONS

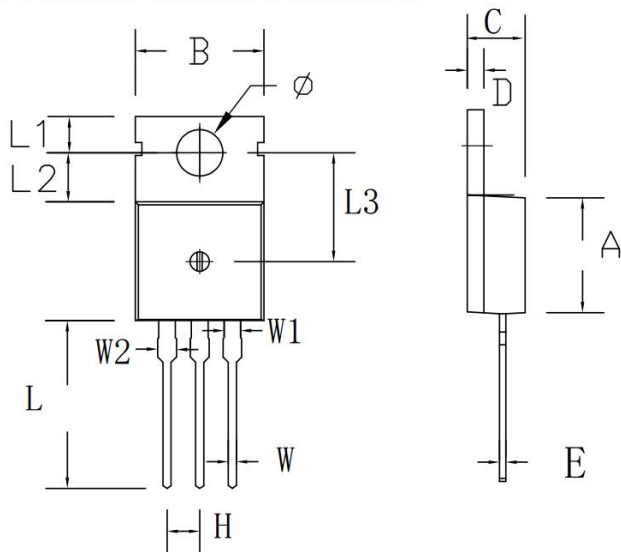

Symbol	Dimensions In Millimeters		Dimensions In Inches	
	min.	max.	min.	max.
A	8.80	9.30	0.346	0.366
B	9.70	10.30	0.382	0.406
C	4.25	4.75	0.167	0.187
D	1.20	1.45	0.047	0.057
E	0.40	0.60	0.016	0.024
H	2.54 TYP		0.100 TYP	
W	0.60	0.95	0.024	0.037
W1	1.05	1.45	0.041	0.057
W2	1.20	1.60	0.047	0.063
L	12.60	13.40	0.496	0.528
L1	2.45	2.95	0.096	0.116
L2	3.45	3.95	0.136	0.156
L3	8.15	8.65	0.321	0.341
φ	3.50	3.90	0.138	0.154

## TO-263 PACKAGE OUTLINE DIMENSIONS

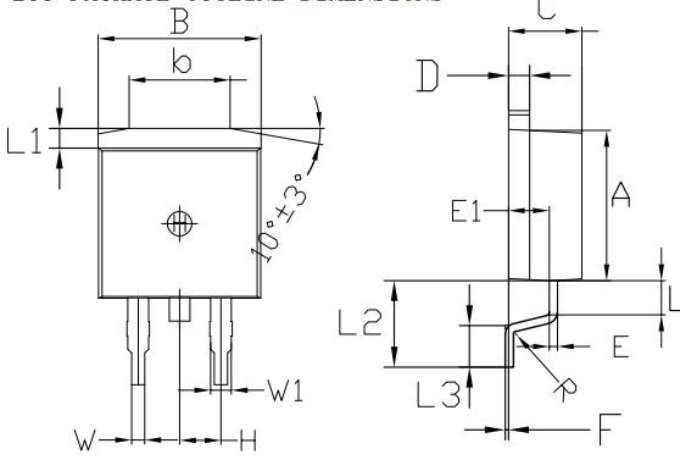

Symbol	Dimensions In Millimeters		Dimensions In Inches	
	min.	max.	min.	max.
A	8.80	9.30	0.346	0.366
B	9.70	10.30	0.382	0.406
C	4.25	4.75	0.167	0.187
D	1.20	1.45	0.047	0.057
E	0.40	0.60	0.016	0.024
L	12.25	13.75	0.482	0.541
L1	1.15	1.45	0.045	0.057
R	0.24	0.26	0.0095	0.0102
W	0.80	0.82	0.0315	0.0323
W1	1.20	1.30	0.047	0.051
H	2.54 TYP		0.200 TYP	
b	5.50	6.50	0.216	0.256
E1	2.4	2.6	0.0946	0.1024
L2	5.20	5.80	0.205	0.228
L3	2.20	3.20	0.087	0.126
F	0.03	0.23	0.0012	0.0091

## TO-220M PACKAGE OUTLINE DIMENSIONS

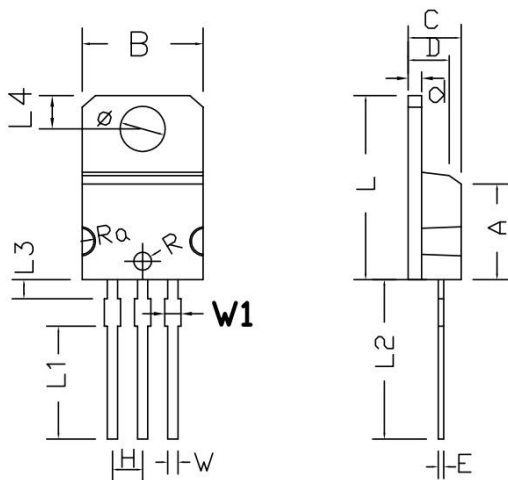

Symbol	Dimensions In Millimeters		Dimensions In Inches	
	min.	max.	min.	max.
	MIN	MAX	MIN	MAX
A	7.55	8.05	0.297	0.317
B	9.85	10.25	0.388	0.404
C	4.20	4.80	0.165	0.189
D	3.20	3.60	0.126	0.142
E	0.42	0.47	0.017	0.019
L	15.20	15.60	0.598	0.614
H	2.52	2.56	0.099	0.101
W	0.78	0.88	0.031	0.035
$\phi$	3.60	3.90	0.142	0.154
R	0.72	0.78	0.028	0.031
$R_a$	9.00	10.5	0.354	0.413
d	1.10	1.40	0.043	0.055
L1	9.3	9.7	0.366	0.382
L2	13.00	13.60	0.512	0.535
L3	1.20	1.70	0.047	0.067
L4	2.60	3.0	0.102	0.118
W1	1.10	1.50	0.043	0.059

TO-251 PACKAGE OUTLINE DIMENSIONS

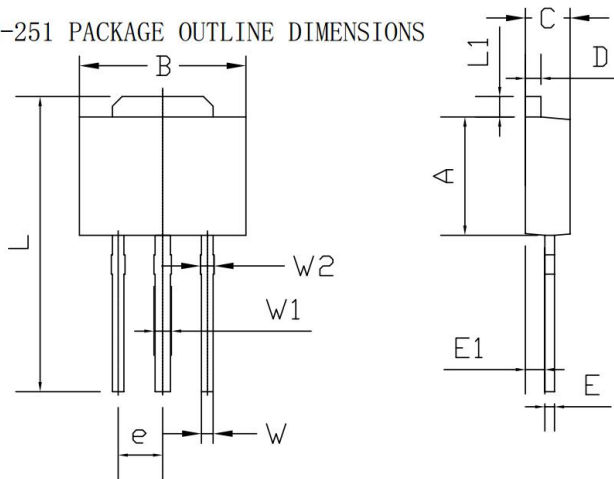

Symbol	Dimensions In Millimeters		Dimensions In Inches	
	min.	max.	min.	max.
A	6.00	6.20	0.236	0.244
B	2.25	2.35	0.089	0.093
C	2.45	2.65	0.097	0.104
D	0.75	0.85	0.030	0.033
E	8.48	8.52	0.3341	0.3357
E1	5.10	5.46	0.201	0.215
e	2.29	2.31	0.0902	0.0910
L	15.00	15.40	0.5910	0.6068
L1	1.00	1.10	0.0394	0.0433
W	0.55	0.65	0.0217	0.0256
W1	0.85	0.95	0.0335	0.0374
W2	0.65	0.75	0.0256	0.0296

TO-252 PACKAGE OUTLINE DIMENSIONS

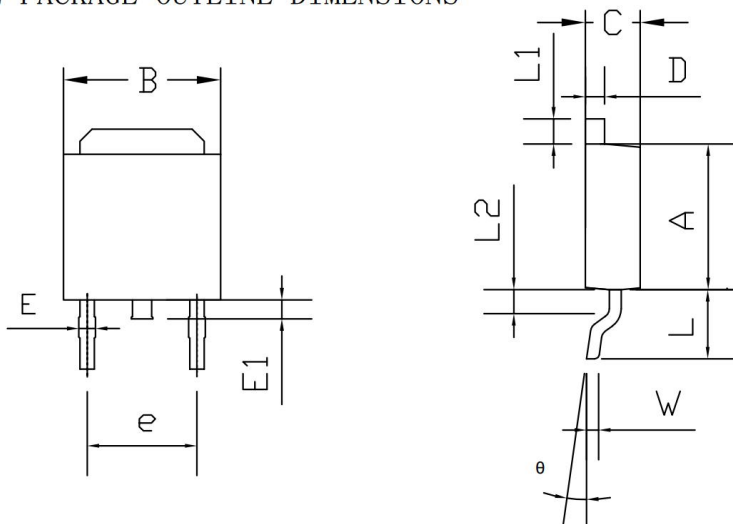

Symbol	Dimensions In Millimeters		Dimensions In Inches	
	min.	max.	min.	max.
A	6.00	6.20	0.236	0.244
B	6.49	6.69	0.256	0.263
C	2.20	2.40	0.087	0.094
D	0.75	0.85	0.030	0.033
E	0.65	0.75	0.0256	0.0296
E1	0.70	0.90	0.028	0.035
e	4.58	4.62	0.1805	0.1820
L	2.85	2.95	0.112	0.116
L1	1.00	1.10	0.0394	0.0433
L2	0.70	0.90	0.0276	0.0355
W	0.48	0.52	0.019	0.020
e	0	8	0	8



## 9 Attentions

- Jiangsu Donghai Semiconductor Co.,Ltd. reserves the right to change the specification without prior notice! The customer should obtain the latest version of the information before making the order and verify that the information is complete and up to date.
- It is the responsibility of the purchaser for any failure or failure of any semiconductor product under certain conditions. It is the responsibility of the purchaser to comply with safety standards and to take safety measures in the system design and machine manufacturing of Jiangsu Donghai Semiconductor Co.,Ltd. products in order to avoid potential risk of failure. Injury or property damage.
- Product promotion is endless, our company will be dedicated to provide customers with better products.

## 10 Appendix

Revision history:

Date	REV.	Description	Page
2018.04.24	1.0	Original	
2022.01.01	1.1	Modify company name	all