

70A 200V Fast recovery diode

1 Description

70A, 200V Ultrafast Diodes They have a low forward voltage drop and are of planar, silicon nitride passivated, ion-implanted, epitaxial construction. These devices are intended for use as energy steering/clamping diodes and rectifiers in a variety of switching power supplies and other power switching applications. Their low stored charge and ultrafast recovery with soft recovery characteristics minimizes ringing and electrical noise in many power switching circuits, thus reducing power loss in the switching transistor

2 Features

- Low power loss,
- high efficiency Low forward voltage,
- high current capability High surge capacity
- Super fast recovery times
- high voltage

3 Applications

- Switching Power Supply
- Power Switching Circuits
- Inverter power supply

4 Electrical Characteristics

4.1 Absolute Maximum Ratings (Tc=25°C, unless otherwise noted)

PARAMETER		SYMBOL	VALUE	UNIT
Peak Repetitive Reverse Voltage		V_{RRM}	200	V
Working Peak Reverse Voltage		V_{RWM}	200	V
DC Blocking Voltage		V_R	200	V
Average Rectified Forward Current(single)	Tc=135°C	$I_{F(AV)}$	35	A
Average Rectified Forward Current(double)	Tc=135°C		70	A
Repetitive Peak Surge Current(single)		I_{FRM}	45	A
Nonrepetitive Peak Surge Current(single)	tp=8.3ms	I_{FSM}	350	A
Avalanche Energy(single)	L=1mH	E_{AS}	72	mJ
Operating Junction Temperature Range		T_j	-55~175	°C
Storage Temperature Range		T_{stg}	-55~175	°C

4.2 Thermal Characteristics

PARAMETER	SYMBOL	VALUE			UNIT
		TO-3P	TO-3PN	TO-247	
Thermal Resistance, Junction to Case-sink	R_{thJC}	0.7	0.7	0.6	°C/W

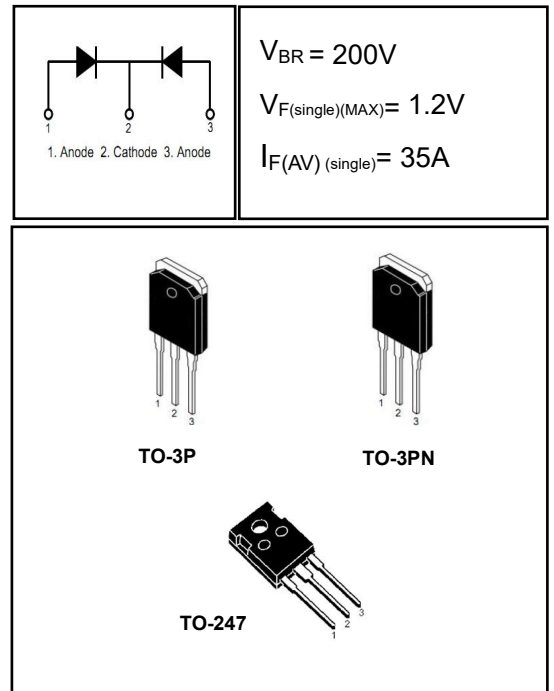

4.3 Electrical Characteristics (Tc=25°C, unless otherwise noted)

PARAMETER	SYMBOL	TEST CONDITION	MIN	TYP	MAX	UNIT
Maximum Instantaneous Forward Voltage	V _F	I _F = 20A	-	0.85	-	V
		I _F = 35A	-	0.88	1.2	V
		I _F = 35A, T _C = 150°C	-	-	1.0	V
		I _F = 40A	-	0.91	1.3	V
Maximum Instantaneous Reverse	I _R	V _R = 200V	-	0.17	1	μA
		V _R = 200V, T _C = 150°C	-	-	5	mA
Maximum Reverse Recovery Time	t _{rr}	V _R =30V I _F =1A -di/dt=50A/us	-	26	40	ns
Total capacitance	C _{tot}	V _R =0V f=1MHz	-	220	-	pF
DC Blocking Voltage	V _{BR}	I _R =100μA	210	250	-	V

DEFINITIONS

V_F = Instantaneous forward voltage (pw = 300μs, D = 2%).

I_R = Instantaneous reverse current.

RθJC = Thermal resistance junction to case.

pw = pulse width.

D = duty cycle.

5 Typical characteristics diagrams

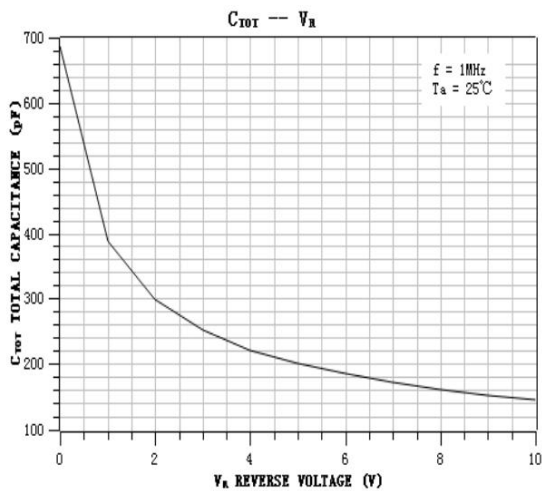

FIGURE 1. Total capacitance vs Voltage

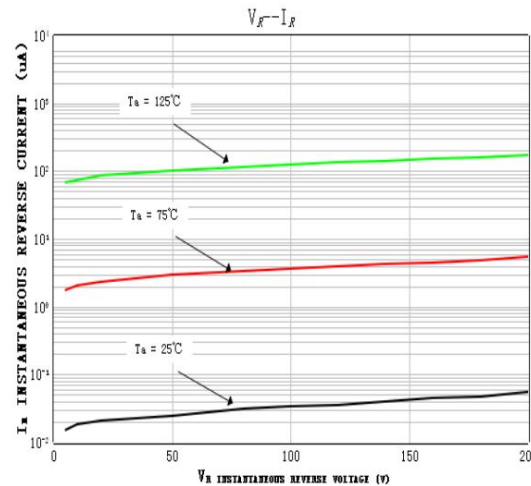

FIGURE 2. REVERSE CURRENT vs REVERSE VOLTAGE

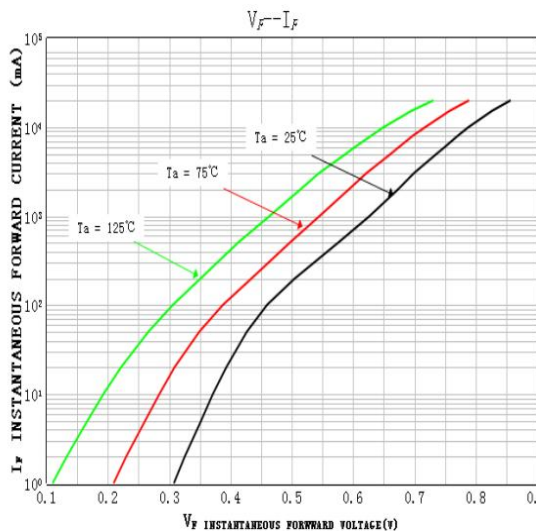

FIGURE 3. FORWARD CURRENT vs FORWARD VOLTAGE

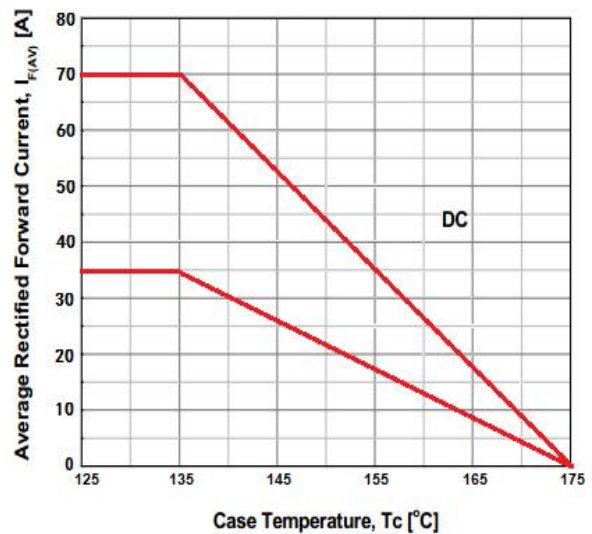

FIGURE 4. CURRENT DERATING CURVE

6 Typical Test Circuit and Waveform

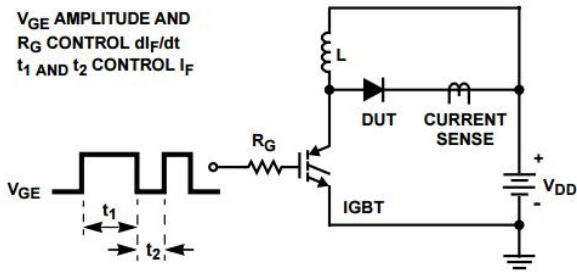

FIGURE 5. trr TEST CIRCUIT

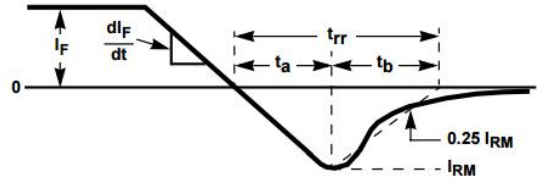

FIGURE 6. trr WAVEFORMS AND DEFINITIONS

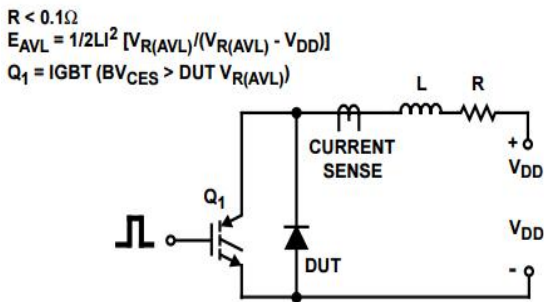

FIGURE 7. AVALANCHE ENERGY TEST CIRCUIT FIGURE

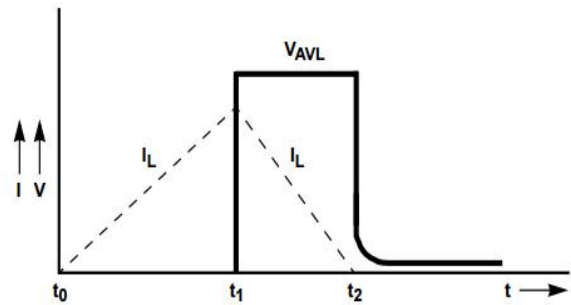
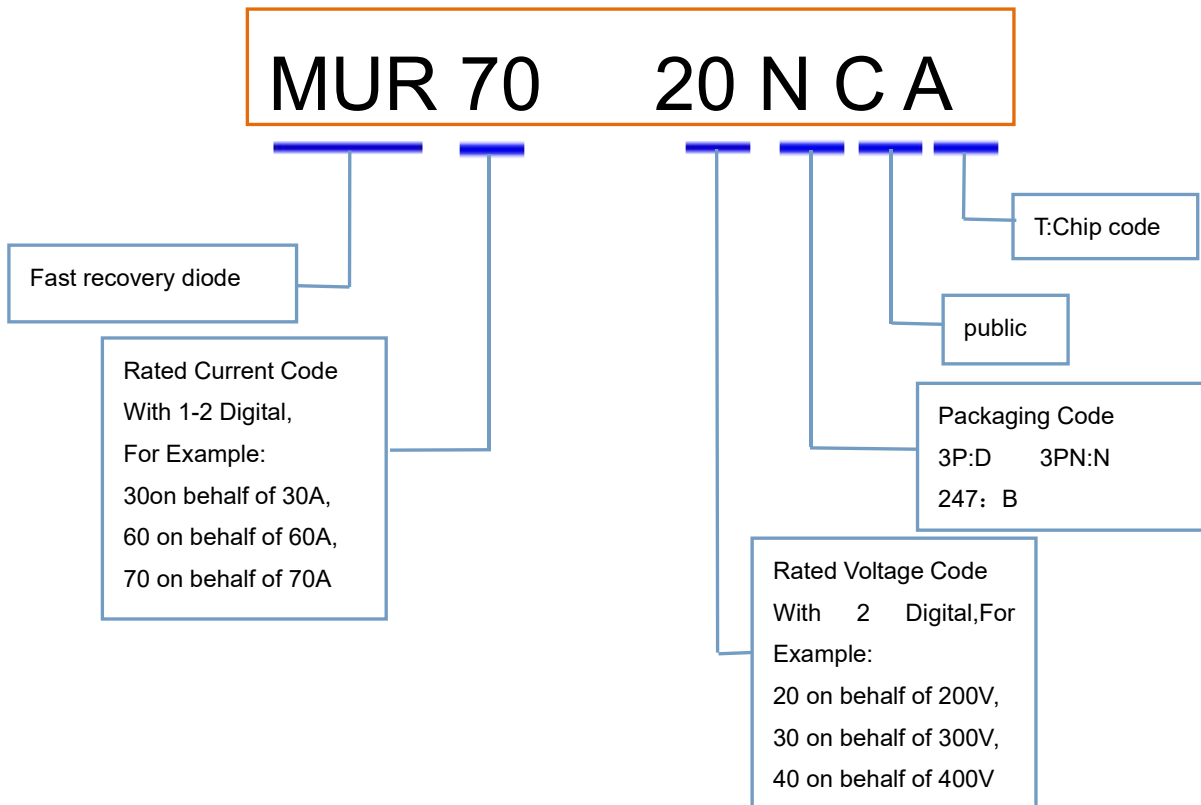

FIGURE 8. AVALANCHE CURRENT AND VOLTAGE WAVEFORMS

7 Product Names Rules



8 Product Specifications and Packaging Models

Product Model	Package Type	Mark Name	RoHS	Package	Quantity
MUR7020NCA	TO-3PN	MUR7020NCA	Pb-free	Tube	300/box
MUR7020BCA	TO-247	MUR7020BCA	Pb-free	Tube	300/box
MUR7020DCA	TO-3P	MUR7020DCA	Pb-free	Tube	300/box

9 Dimensions

TO-247 PACKAGE OUTLINE DIMENSIONS

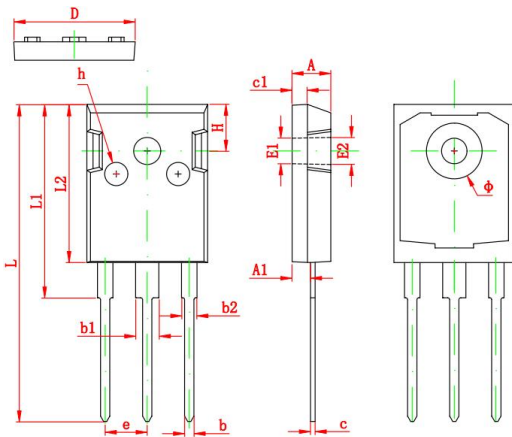

Symbol	Dimensions In Millimeters		Dimensions In Inches	
	Min	Max	Min	Max
A	4.850	5.150	0.191	0.200
A1	2.200	2.600	0.087	0.102
b	1.000	1.400	0.039	0.055
b1	2.800	3.200	0.110	0.126
b2	1.800	2.200	0.071	0.087
c	0.500	0.700	0.020	0.028
c1	1.900	2.100	0.075	0.083
D	15.450	15.750	0.608	0.620
E1	3.500 REF		0.138 REF	
E2	3.600 REF		0.142 REF	
L	40.900	41.300	1.610	1.626
L1	24.800	25.100	0.976	0.988
L2	20.300	20.600	0.799	0.811
Φ	7.100	7.300	0.280	0.287
e	5.450 TYP		0.215 TYP	
H	5.980 REF		0.235 REF	
h	0.000	0.300	0.000	0.012

TO-3P PACKAGE OUTLINE DIMENSIONS

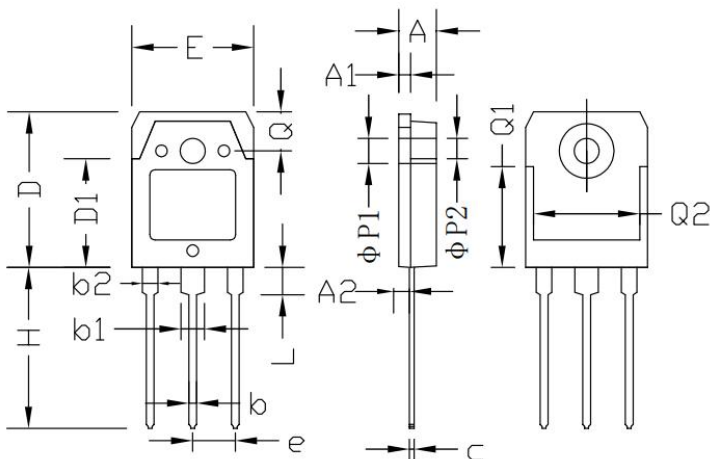

Symbol	Dimensions In Millimeters		Dimensions In Inches	
	min.	max.	min.	max.
A	4.60	5.00	0.181	0.197
A1	1.45	1.65	0.057	0.065
A2	1.20	1.60	0.047	0.063
b	0.80	1.20	0.032	0.047
b1	2.80	3.20	0.110	0.126
b2	1.80	2.20	0.071	0.087
C	0.55	0.75	0.022	0.030
D	19.20	19.80	0.756	0.780
D1	13.10	14.70	0.516	0.578
E	15.40	15.80	0.607	0.623
e	5.45 TYP		0.215 TYP	
H	19.80	20.50	0.780	0.807
L	3.20	3.70	0.126	0.146
ΦP1	3.20 TYP		0.126 TYP	
ΦP2	3.50 TYP		0.138 TYP	
Q	5.00 TYP		0.197 TYP	
Q1	12.40 TYP		0.488 TYP	
Q2	12.6	-	0.496	-

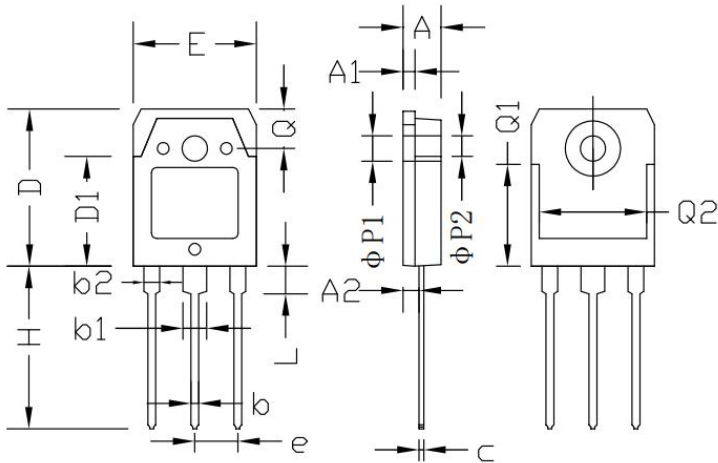
TO-3PN PACKAGE OUTLINE DIMENSIONS

Symbol	Dimensions In Millimeters		Dimensions In Inches	
	min.	max.	min.	max.
A	4.60	5.00	0.181	0.197
A1	1.45	1.65	0.057	0.065
A2	2.20	2.60	0.087	0.102
b	0.80	1.20	0.032	0.047
b1	2.80	3.20	0.110	0.126
b2	1.80	2.20	0.071	0.087
C	0.55	0.75	0.022	0.030
D	19.20	19.80	0.756	0.780
D1	13.10	14.70	0.516	0.578
E	15.40	15.80	0.607	0.623
e	5.45 TYP		0.215 TYP	
H	19.80	20.50	0.780	0.807
L	3.20	3.70	0.126	0.146
Φ P1	3.20 TYP		0.126 TYP	
Φ P2	3.50 TYP		0.138 TYP	
Q	5.00 TYP		0.197 TYP	
Q1	12.40 TYP		0.488 TYP	
Q2	12.6	-	0.496	-

10 Attentions

- Jiangsu Donghai Semiconductor Co.,Ltd. reserves the right to change the specification without prior notice! The customer should obtain the latest version of the information before making the order and verify that the information is complete and up to date.
- It is the responsibility of the purchaser for any failure or failure of any semiconductor product under certain conditions. It is the responsibility of the purchaser to comply with safety standards and to take safety measures in the system design and machine manufacturing of Jiangsu Donghai Semiconductor Co.,Ltd. products in order to avoid potential risk of failure. Injury or property damage.
- Product promotion is endless, our company will be dedicated to provide customers with better products.

11 Appendix

Revision history:

Date	REV.	Description	Page
2019.07.23	1.0	Original	
2022.01.01	1.1	Modify company name	all