

10A 600V Fast recovery diode

1 Description

10A, 600V Ultrafast Diodes They have a low forward voltage drop and are of planar, silicon nitride passivated, ion-implanted, epitaxial construction. These devices are intended for use as energy steering/clamping diodes and rectifiers in a variety of switching power supplies and other power switching applications. Their low stored charge and ultrafast recovery with soft recovery characteristics minimizes ringing and electrical noise in many power switching circuits, thus reducing power loss in the switching transistor TO-220F provides insulation voltage rated at 2000V RMS from all three terminals to external heatsink.

2 Features

- Low power loss,
- high efficiency Low forward voltage,
- high current capability High surge capacity
- Super fast recovery times
- high voltage

3 Applications

- Switching Power Supply
- Power Switching Circuits
- General Purpose

4 Electrical Characteristics

4.1 Absolute Maximum Ratings (T_c=25°C, unless otherwise noted)

| PARAMETER | | SYMBOL | VALUE | UNIT |
|---|-----------------------|--------------------|---------|------|
| Peak Repetitive Reverse Voltage | | V _{RRM} | 600 | V |
| Working Peak Reverse Voltage | | V _{RWM} | 600 | V |
| DC Blocking Voltage | | V _R | 600 | V |
| Average Rectified Forward Current(single) | TO-220/263, TC=135°C | I _{F(AV)} | 5 | A |
| Average Rectified Forward Current(double) | TO-220F, TC=100°C | | 10 | A |
| Repetitive Peak Surge Current | | I _{FRM} | 20 | A |
| Nonrepetitive Peak Surge Current(single) | t _p =8.3ms | I _{FSM} | 80 | A |
| Avalanche Energy | L=1mH | E _{AS} | 40 | mJ |
| Maximum Power Dissipation | T _c =25°C | P _D | 60 | W |
| Operating Junction Temperature Range | | T _j | -55~150 | °C |
| Storage Temperature Range | | T _{stg} | -55~150 | °C |

4.2 Thermal Characteristics

| PARAMETER | SYMBOL | VALUE | | | UNIT |
|---|-------------------|--------|---------|--------|------|
| | | TO-220 | TO-220F | TO-263 | |
| Thermal Resistance, Junction to Case-sink | R _{thJC} | 2.5 | 3.5 | 3.0 | °C/W |

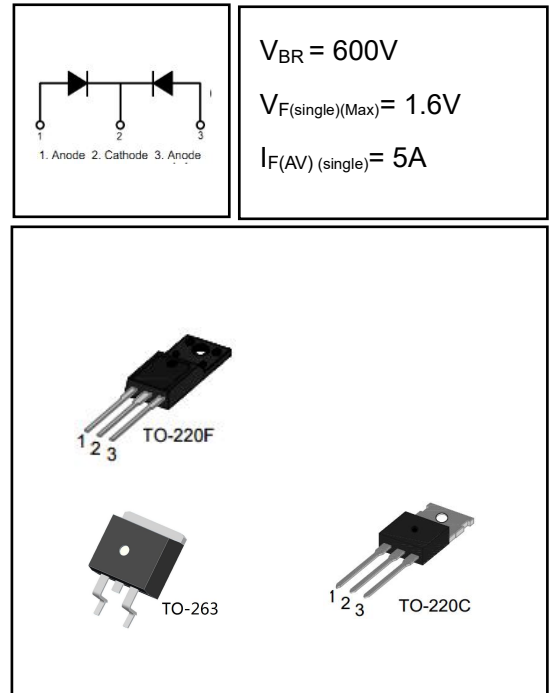

4.3 Electrical Characteristics (Tc=25°C, unless otherwise noted)

| PARAMETER | SYMBOL | TEST CONDITION | MIN | TYP | MAX | UNIT |
|---------------------------------------|------------------|--|-----|------|------|------|
| Maximum Instantaneous Forward Voltage | V _F | I _F = 5A | - | 1.35 | 1.6 | V |
| | | I _F = 5A, T _C = 150°C | - | - | 1.45 | V |
| | | I _F = 10A | - | 1.55 | 1.8 | V |
| Maximum Instantaneous Reverse | I _R | V _R = 600V | - | - | 5 | uA |
| | | V _R = 600V, T _C = 150°C | - | - | 500 | uA |
| Maximum Reverse Recovery Time | t _{rr} | V _R =30V I _F =1A -di/dt=50A/us | - | 25 | 35 | ns |
| Total capacitance | C _{tot} | V _R =0V f=1MHz | - | 58 | - | pF |
| DC Blocking Voltage | V _{BR} | I _R =100uA | 610 | 640 | - | V |

DEFINITIONS

V_F = Instantaneous forward voltage (pw = 300μs, D = 2%).

I_R = Instantaneous reverse current.

RθJC = Thermal resistance junction to case.

pw = pulse width.

D = duty cycle.

5 Typical characteristics diagrams

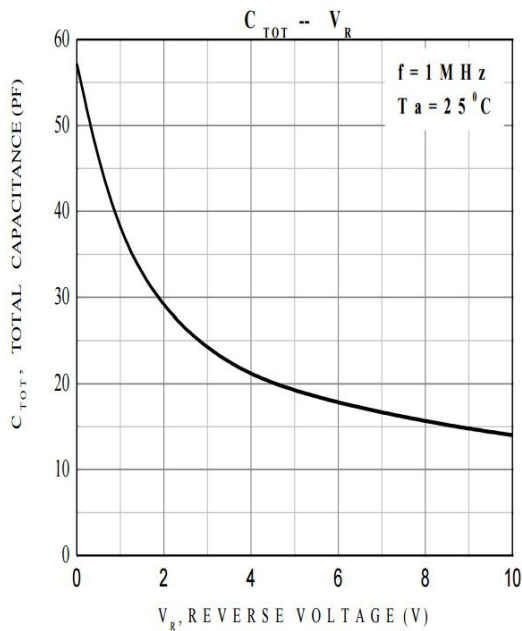

FIGURE 1. Total capacitance vs Voltage

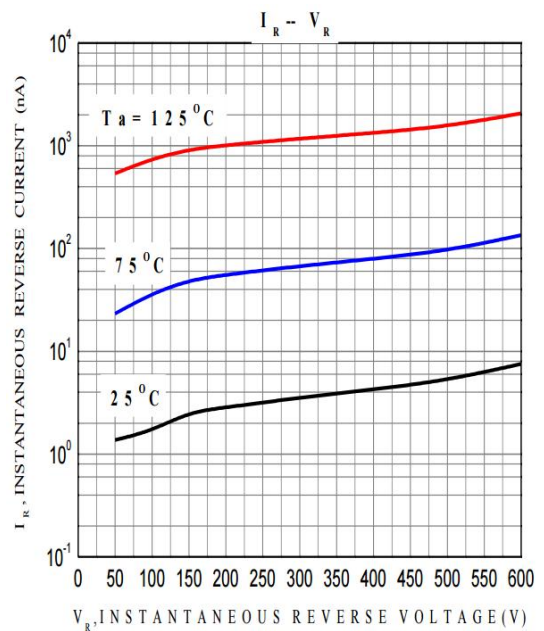

FIGURE 2. REVERSE CURRENT vs REVERSE VOLTAGE

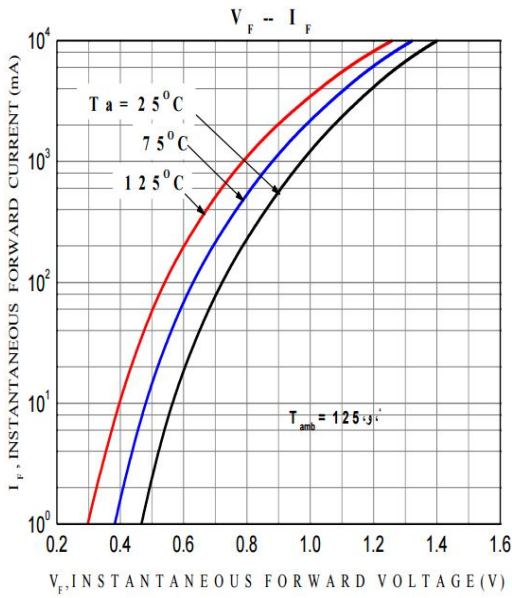

FIGURE 3. FORWARD CURRENT vs FORWARD VOLTAGE

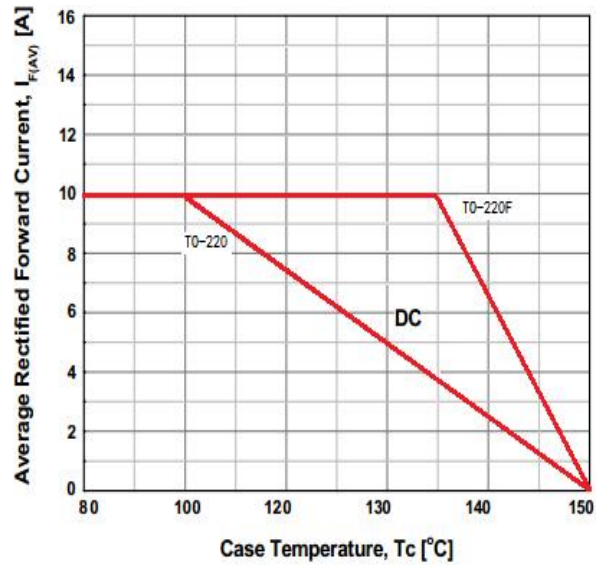

FIGURE 4. CURRENT DERATING CURVE

6 Typical Test Circuit and Waveform

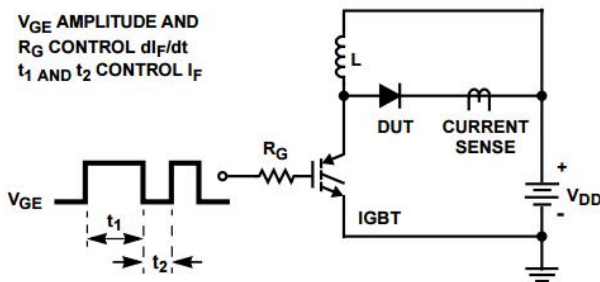

FIGURE 5. trr TEST CIRCUIT

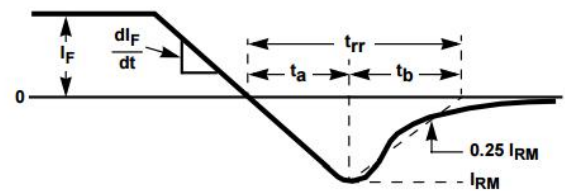

FIGURE 6. trr WAVEFORMS AND DEFINITIONS

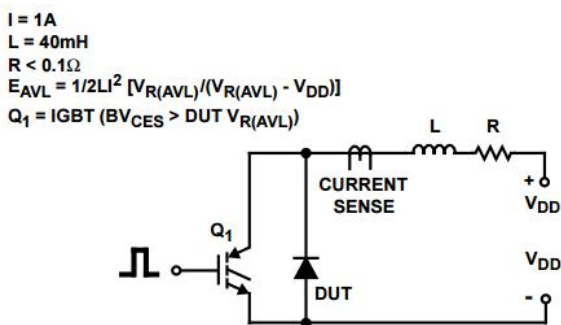

FIGURE 7. AVALANCHE ENERGY TEST CIRCUIT FIGURE

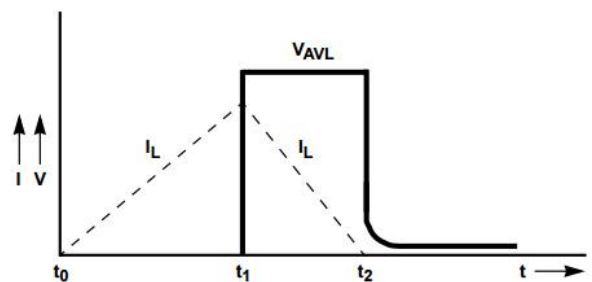

FIGURE 8. AVALANCHE CURRENT AND VOLTAGE WAVEFORMS

7 Product Specifications and Packaging Models

| Product Model | Package Type | Mark Name | RoHS | Package | Quantity |
|---------------|--------------|------------|---------|---------|----------|
| MUR1060CT | TO-220 | MUR1060CT | Pb-free | Tube | 1000/box |
| MURF1060CT | TO-220F | MURF1060CT | Pb-free | Tube | 1000/box |

8 Dimensions

TO-220F PACKAGE OUTLINE DIMENSIONS

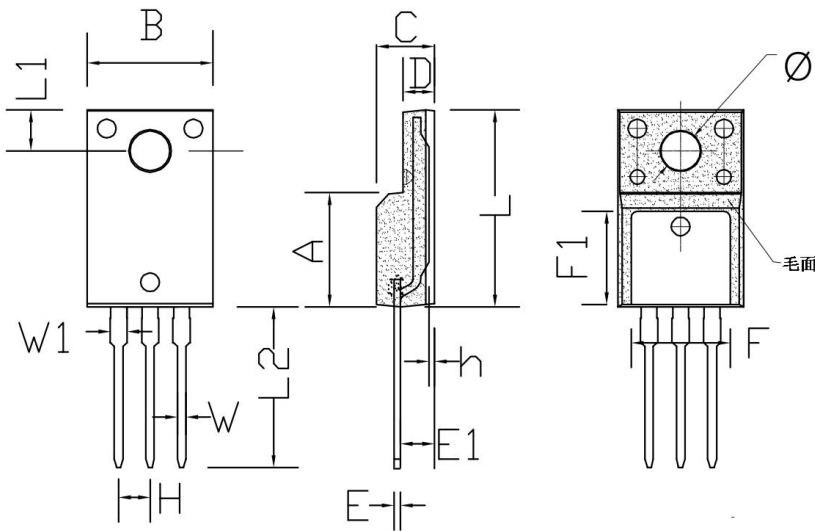

| Symbol | Dimensions In Millimeters | | Dimensions In Inches | |
|--------|---------------------------|-------|----------------------|-------|
| | min. | max. | min. | max. |
| A | 8.80 | 9.30 | 0.346 | 0.366 |
| B | 10.00 | 10.50 | 0.394 | 0.413 |
| C | 4.30 | 4.90 | 0.169 | 0.193 |
| D | 2.30 | 2.70 | 0.091 | 0.106 |
| L | 15.55 | 16.15 | 0.612 | 0.636 |
| h | 0.40 | 0.60 | 0.016 | 0.024 |
| L1 | 3.15 | 3.55 | 0.124 | 0.140 |
| L2 | 12.65 | 13.35 | 0.498 | 0.526 |
| W | 0.70 | 0.90 | 0.028 | 0.035 |
| W1 | 1.15 | 1.55 | 0.045 | 0.061 |
| H | 2.54 TYP | | 0.100 TYP | |
| E | 0.48 | 0.53 | 0.019 | 0.021 |
| φ | 2.90 | 3.40 | 0.114 | 0.134 |
| E1 | 2.40 | 2.90 | 0.094 | 0.114 |
| F | 7.75 | 8.25 | 0.305 | 0.325 |
| F1 | 7.35 | 7.85 | 0.289 | 0.309 |

TO-263 PACKAGE OUTLINE DIMENSIONS

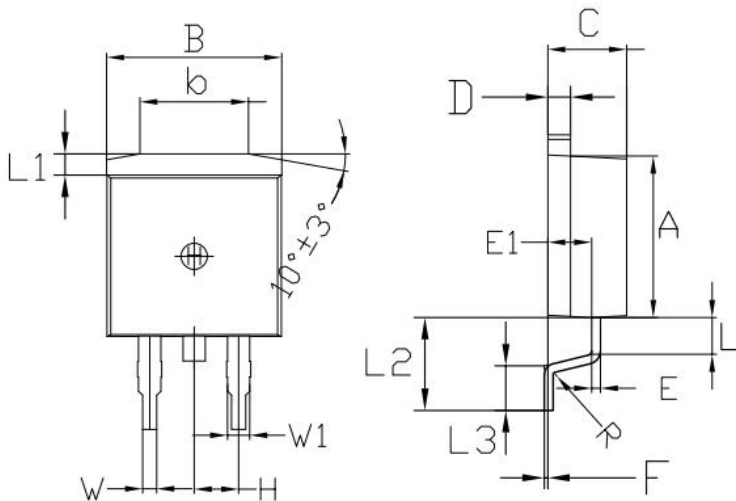

| Symbol | Dimensions In Millimeters | | Dimensions In Inches | |
|--------|---------------------------|-------|----------------------|--------|
| | min. | max. | min. | max. |
| A | 8.80 | 9.30 | 0.346 | 0.366 |
| B | 9.70 | 10.30 | 0.382 | 0.406 |
| C | 4.25 | 4.75 | 0.167 | 0.187 |
| D | 1.20 | 1.45 | 0.047 | 0.057 |
| E | 0.40 | 0.60 | 0.016 | 0.024 |
| L | 12.25 | 13.75 | 0.482 | 0.541 |
| L1 | 1.15 | 1.45 | 0.045 | 0.057 |
| R | 0.24 | 0.26 | 0.0095 | 0.0102 |
| W | 0.80 | 0.82 | 0.0315 | 0.0323 |
| W1 | 1.20 | 1.30 | 0.047 | 0.051 |
| H | 2.54 TYP | | 0.200 TYP | |
| b | 5.50 | 6.50 | 0.216 | 0.256 |
| E1 | 2.4 | 2.6 | 0.0946 | 0.1024 |
| L2 | 5.20 | 5.80 | 0.205 | 0.228 |
| L3 | 2.20 | 3.20 | 0.087 | 0.126 |
| F | 0.03 | 0.23 | 0.0012 | 0.0091 |

TO-220C PACKAGE OUTLINE DIMENSIONS

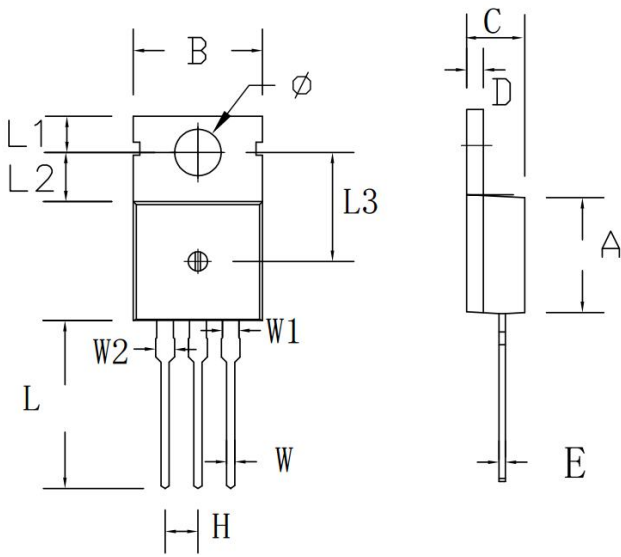

| Symbol | Dimensions In Millimeters | | Dimensions In Inches | |
|--------|---------------------------|-------|----------------------|-------|
| | min. | max. | min. | max. |
| A | 8.80 | 9.30 | 0.346 | 0.366 |
| B | 9.70 | 10.30 | 0.382 | 0.406 |
| C | 4.25 | 4.75 | 0.167 | 0.187 |
| D | 1.20 | 1.45 | 0.047 | 0.057 |
| E | 0.40 | 0.60 | 0.016 | 0.024 |
| H | 2.54 TYP | | 0.100 TYP | |
| W | 0.60 | 0.95 | 0.024 | 0.037 |
| W1 | 1.05 | 1.45 | 0.041 | 0.057 |
| W2 | 1.20 | 1.60 | 0.047 | 0.063 |
| L | 12.60 | 13.40 | 0.496 | 0.528 |
| L1 | 2.45 | 2.95 | 0.096 | 0.116 |
| L2 | 3.45 | 3.95 | 0.136 | 0.156 |
| L3 | 8.15 | 8.65 | 0.321 | 0.341 |
| ϕ | 3.50 | 3.90 | 0.138 | 0.154 |

9 Attentions

- Jiangsu Donghai Semiconductor Co.,Ltd. reserves the right to change the specification without prior notice! The customer should obtain the latest version of the information before making the order and verify that the information is complete and up to date.
- It is the responsibility of the purchaser for any failure or failure of any semiconductor product under certain conditions. It is the responsibility of the purchaser to comply with safety standards and to take safety measures in the system design and machine manufacturing of Jiangsu Donghai Semiconductor Co.,Ltd. products in order to avoid potential risk of failure. Injury or property damage.
- Product promotion is endless, our company will be dedicated to provide customers with better products.

10 Appendix

Revision history:

| Date | REV. | Description | Page |
|------------|------|---------------------|------|
| 2017.03.31 | 1.0 | Original | |
| 2022.01.01 | 1.1 | Modify company name | all |