

12A 60V P-channel Enhancement Mode Power MOSFET

1 Description

These P-channel enhanced vdmofets, used advanced trench technology and design, provide to excellent Rdson with low gate charge. Which accords with the RoHS standard.

2 Features

- Fast switching
- Low on resistance
- Low gate charge
- Low reverse transfer capacitances
- 100% single pulse avalanche energy test
- 100% ΔV_{DS} test

3 Applications

- Power switching applications
- Inverter management system
- Power tools
- Automotive electronics

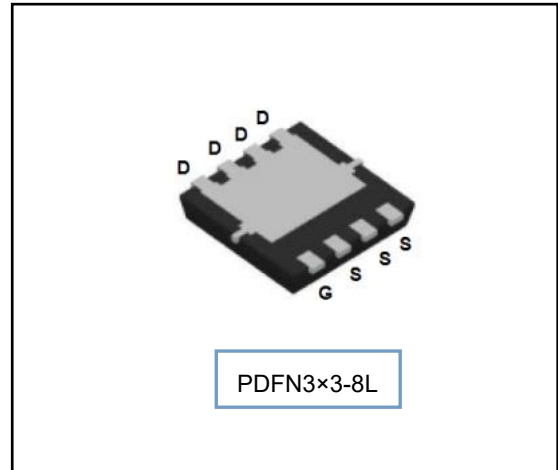
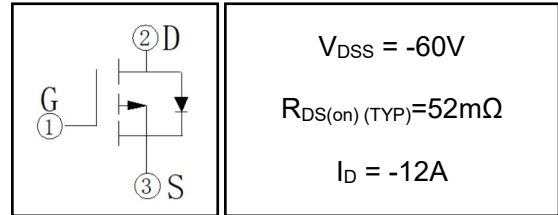

4 Electrical Characteristics

4.1 Absolute Maximum Rating ($T_C=25^\circ C$, unless otherwise noted)

Parameter	Symbol	Value	Unit
Drain-Source Voltage	V_{DSS}	-60	V
Gate-Drain Voltage	V_{GSS}	± 20	V
Drain Current(continuous)	I_D	$T_C=25^\circ C$	-12
		$T_C=100^\circ C$	-7.8
Drain Current(Pulsed) ⁽¹⁾	I_{DM}	-48	A
Single Pulse Avalanche Energy ⁽⁴⁾	E_{AS}	81	mJ
Single Pulse Avalanche Current ⁽⁴⁾	I_{AS}	-18	A
Total Dissipation	P_{tot}	$T_a=25^\circ C$	--
		$T_C=25^\circ C$	28
Junction Temperature	T_j	-55~150	$^\circ C$
storage Temperature	T_{stg}	-55~150	$^\circ C$

4.2 Thermal Characteristics

Parameter	Symbol	Value	Unit
Thermal Resistance Junction to Case-sink	R_{thJC}	4.46	$^\circ C/W$
Thermal Resistance Junction to Ambient	R_{thJA}	--	$^\circ C/W$

4.3 Electrical Characteristics (T_c=25°C, unless otherwise noted)

Parameter	Symbol	Test Condition	Value			Units
			Min	Typ	Max	
Off Characteristics						
Drain-source Breakdown Voltage	BV _{DSS}	I _D =-250μA, V _{GS} =0V	-60	-66	--	V
Drain-to-Source Leakage Current	I _{DSS}	V _{DS} =-60V, V _{GS} =0V, T _C =25°C	--	--	-1	μA
		V _{DS} =-48V, V _{GS} =0V, T _C =125°C	--	--	-100	μA
Gate-to-Source Forward Leakage	I _{GSSF}	V _{GS} =+20V	--	--	100	nA
Gate-to-Source Reverse Leakage	I _{GSSR}	V _{GS} =-20V	--	--	-100	nA
On Characteristics						
Gate threshold Voltage	V _{GS(th)}	V _{DS} =V _{GS} , I _D =-250μA	-1	-1.6	-2	V
Drain-source on-state Resistance	R _{DS(on)}	V _{GS} =-10V, I _D =-10A	--	52	65	mΩ
		V _{GS} =-4.5V, I _D =-10A	--	65	80	
Forward Transfer Conductance	g _{fs}	V _{DS} =-5V, I _D =-8A	--	15	--	S
Dynamic Characteristics						
Input Capacitance	C _{iss}	V _{GS} =0V, V _{DS} =-30V, f=1.0MHz	--	1528	--	pF
Output Capacitance	C _{oss}		--	90	--	
Reverse Transfer Capacitance	C _{rss}		--	60	--	
Switching Characteristics						
Turn-on Delay Time	t _{d(on)}	V _{DD} =-30V, I _D =-8A, V _{GS} =-10V, R _{GEN} =3Ω	--	6.6	--	nS
Turn-on Rise Time	t _r		--	42	--	
Turn-off Delay Time	t _{d(off)}		--	37	--	
Turn-off Fall Time	t _f		--	63.5	--	
Total Gate Charge	Q _g	I _D =-8A, V _{DD} =-30V, V _{GS} =-10V	--	28.2	--	nC
Gate-to-Source Charge	Q _{gs}		--	7.2	--	
Gate-to-Drain("Miller") Charge	Q _{gd}		--	3.8	--	
Drain-Source Diode Characteristics						
Diode Forward Voltage ⁽³⁾	V _{FSD}	V _{GS} =0V, I _S =-10A	--	-0.86	-1.2	V
Diode Forward Current	I _S		--	--	-12	A
Reverse Recovery Time ⁽³⁾	t _{rr}	T _J =25°C, I _F =-8A, dI _F /dt=100A/μS, V _{GS} =0V	--	29	--	nS
Reverse Recovery Charge ⁽³⁾	Q _{rr}		--	12.8	--	nC

Notes:

- 1: Repetitive rating, pulse width limited by maximum junction temperature.
- 2: Surface mounted on FR4 Board, t_s≤10sec.
- 3: Pulse width ≤ 300μs, duty cycle ≤ 2%.
- 4: L=0.5mH, I_D=-18A, V_{DD}=-50V, V_{GATE}=-60V, Start T_J=25°C.

5 Typical characteristics diagrams

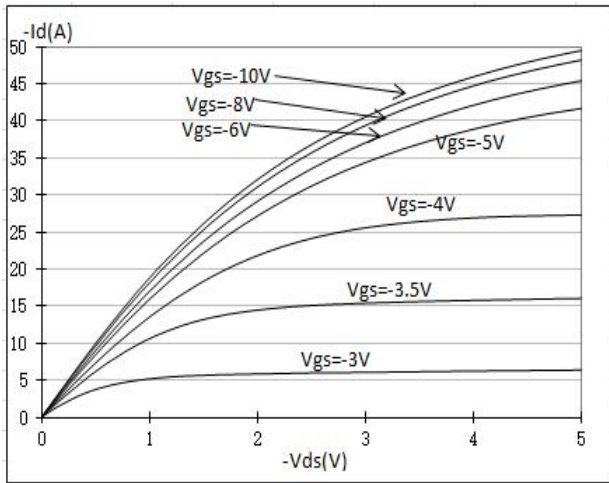

Figure 1 Output Characteristics

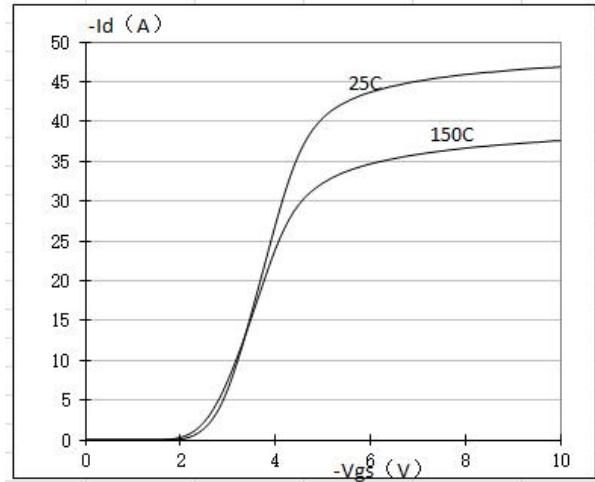

Figure 2 Transfer Characteristics

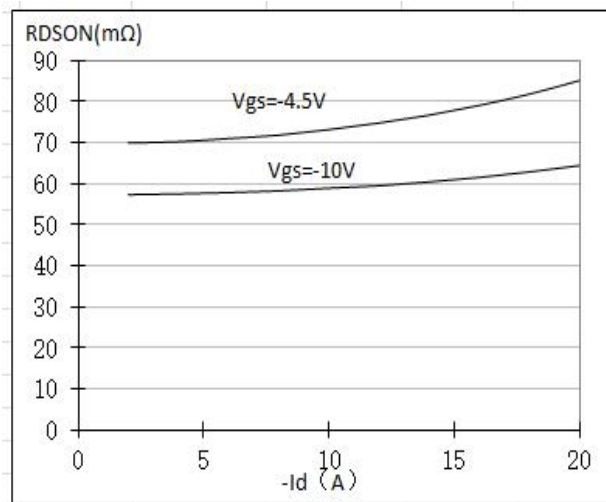

Figure 3. On-resistance vs. Drain Current

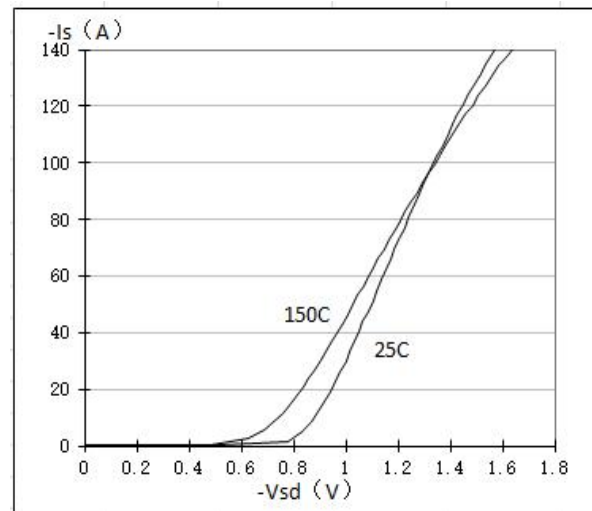

Figure 4. Source- Drain Diode Forward

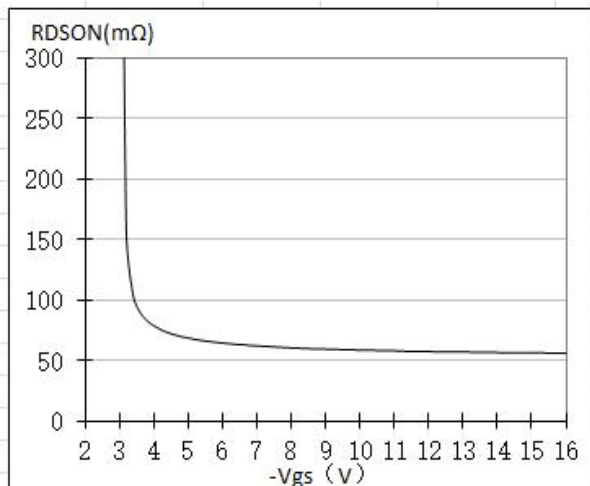

Figure 5. On-resistance vs. V_{gs}

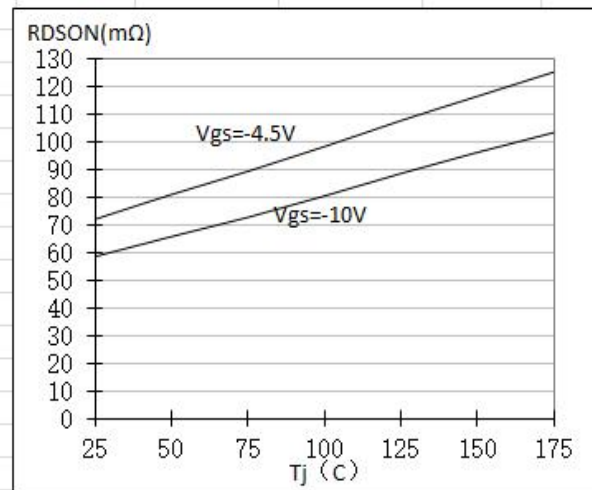

Figure 6. on Resistance vs. Junction Temperature

5 Typical characteristics diagrams(continues)

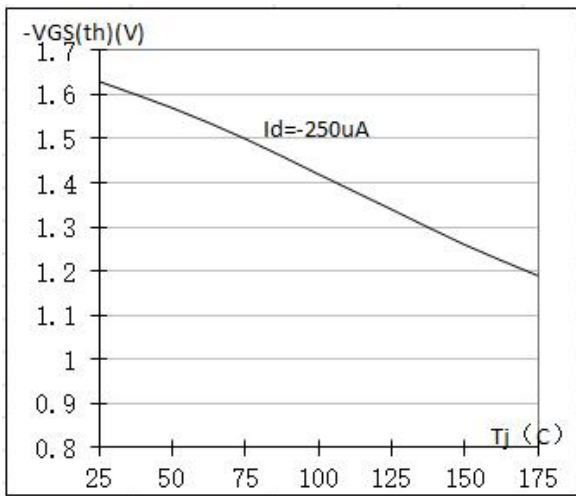

Figure 7. VTH vs. Junction Temperature

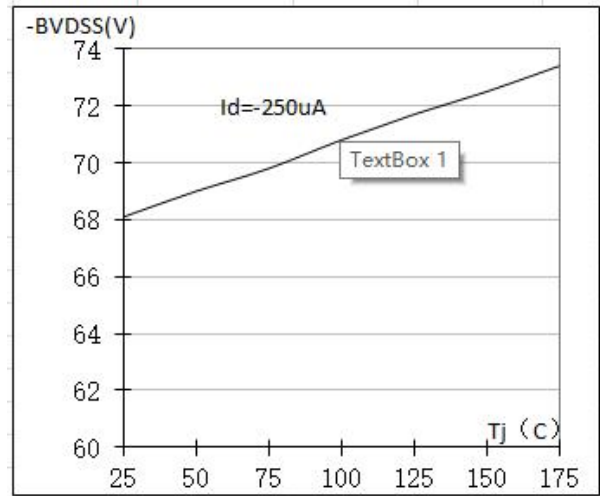

Figure 8. BVdss vs. Junction Temperature

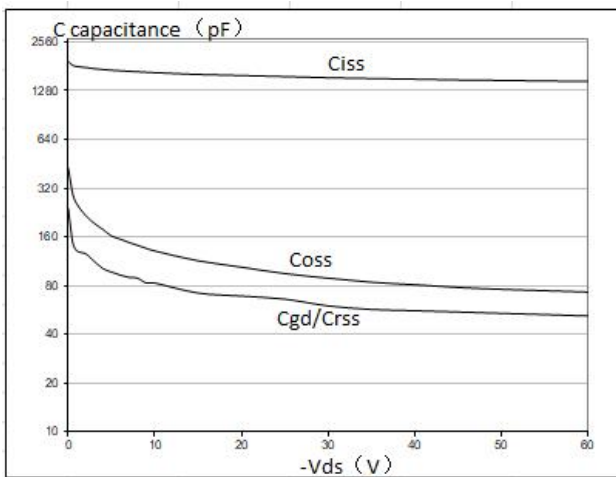

Figure 9. Capacitance vs Vds

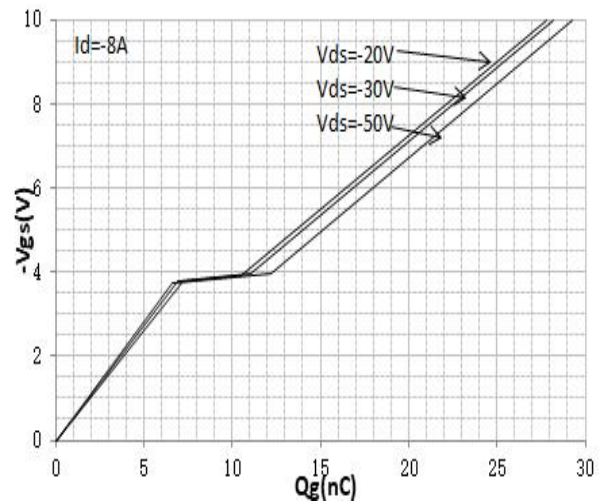
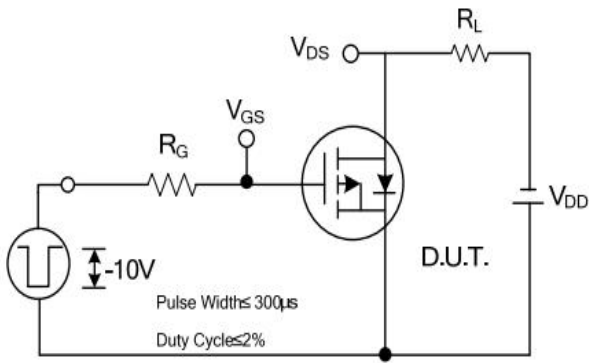
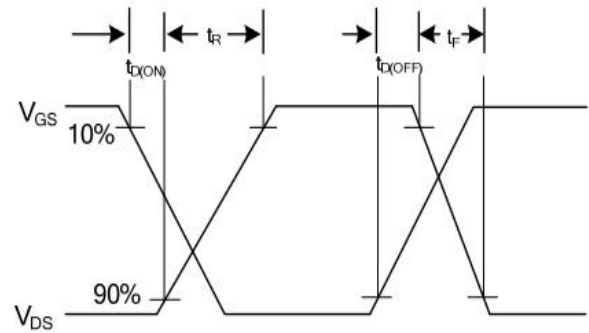

Figure 10. Gate Charge Characteristics

6 Typical Test Circuit and Waveform



Switching Test Circuit



Switching Waveforms

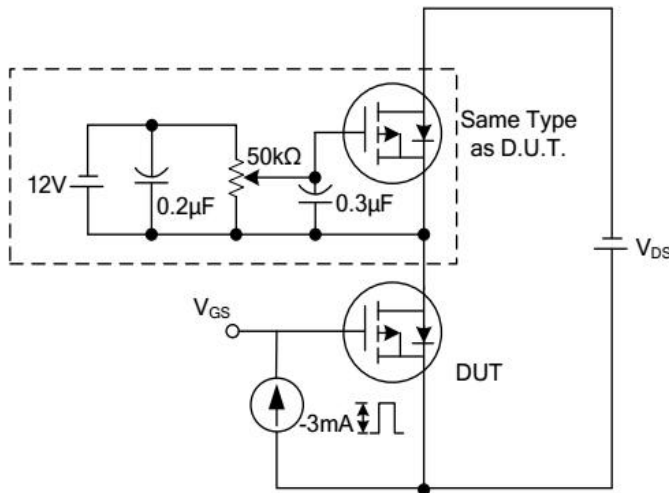

Gate Charge Test Circuit

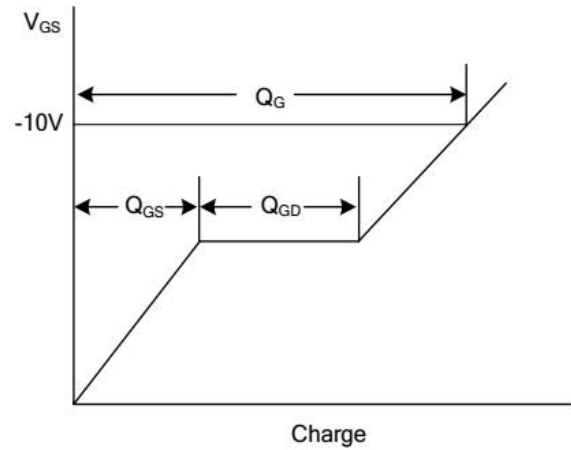

Gate Charge Waveform

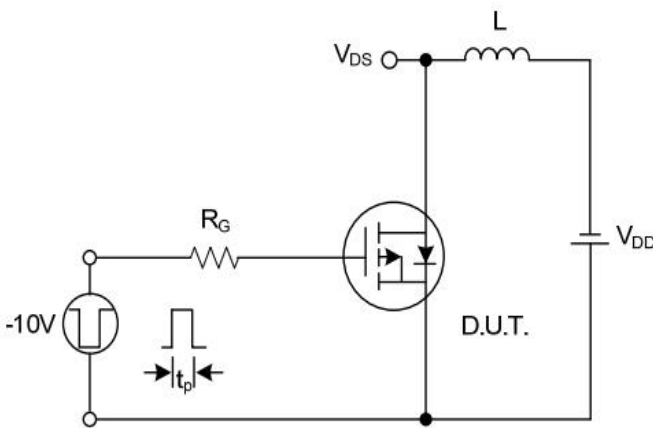

Unclamped Inductive Switching Test Circuit

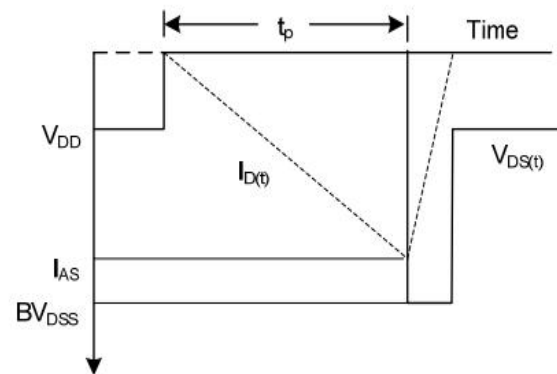

Unclamped Inductive Switching Waveforms

7 Product Names Rules

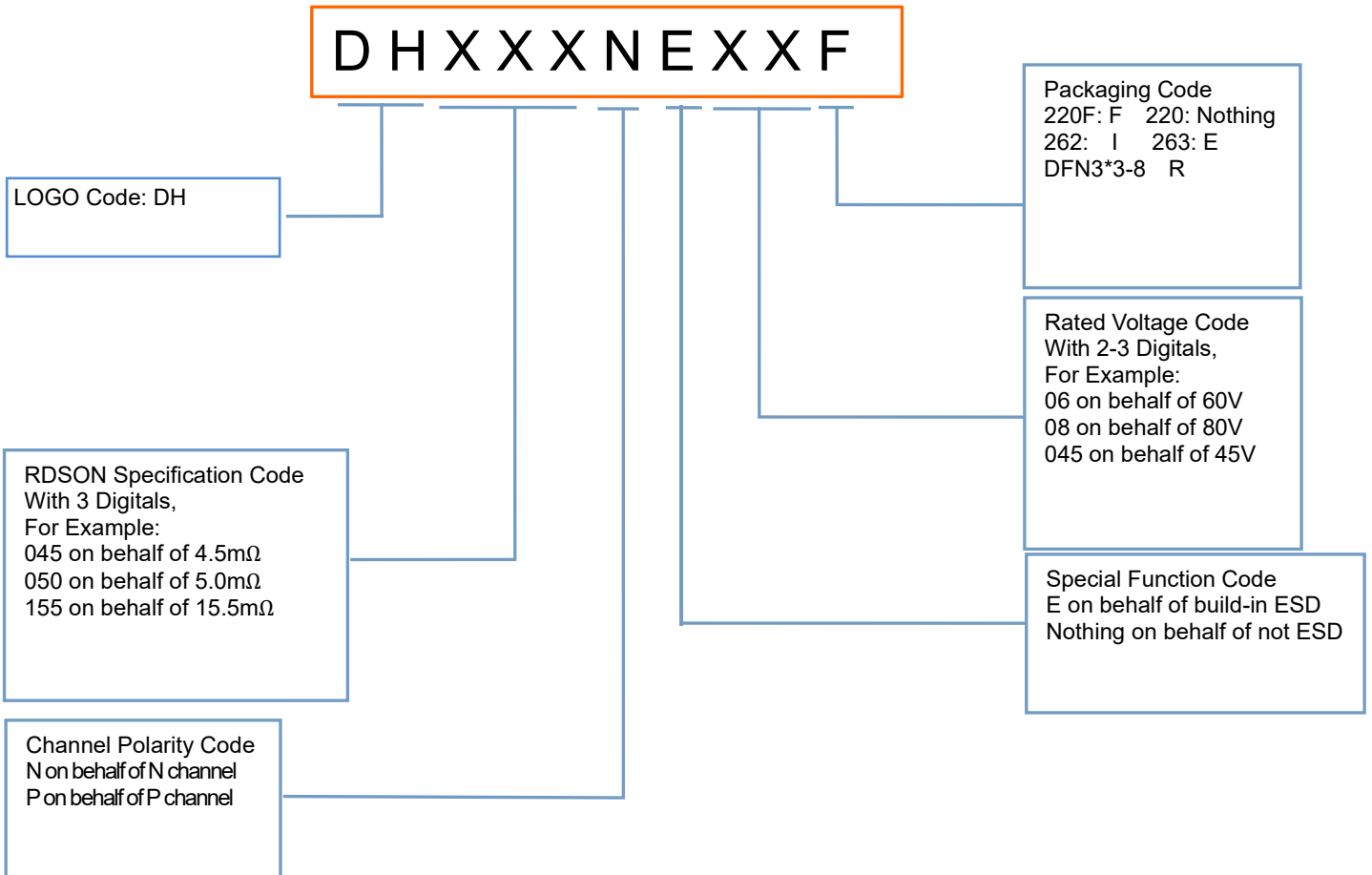

8 Product Specifications and Packaging Models

Product Model	Package Type	Mark Name	RoHS	Package	Quantity
DH500P06R	PDFN3*3-8L	DH500P06R	Pb-free	Tape & Reel	2500/box

9 Dimensions

PDFN3×3-8L

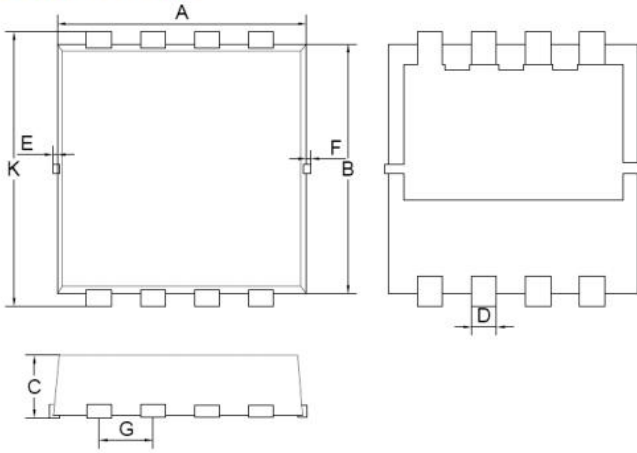

PDFN3X3-8L		
Dim	Min	Max
A	2.90	3.10
B	2.90	3.10
C	0.65	0.85
D	0.20	0.40
E	0.00	0.10
F	0.00	0.10
G	0.55	0.75
K	3.15	3.45

Mounting Pad Layout (unit: mm)

PDFN3×3-8L

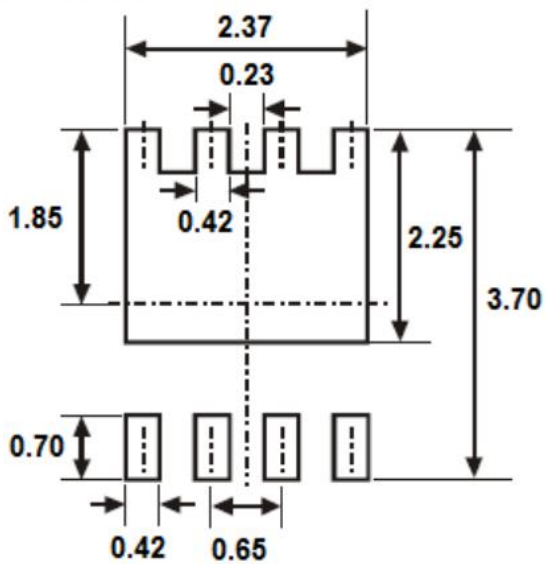

10 Attentions

- Jiangsu Donghai Semiconductor Technology CO.,LTD. reserves the right to change the specification without prior notice! The customer should obtain the latest version of the information before making the order and verify that the information is complete and up to date.
- It is the responsibility of the purchaser for any failure or failure of any semiconductor product under certain conditions. It is the responsibility of the purchaser to comply with safety standards and to take safety measures in the system design and machine manufacturing of Donghai products in order to avoid potential risk of failure. Injury or property damage.
- Product promotion is endless, our company will be dedicated to provide customers with better products.

11 Appendix

Revision history:

Date	REV.	Description	Page
2022.06.25	1.0	Original	